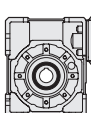
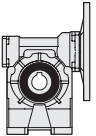
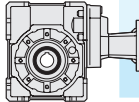
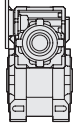
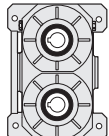
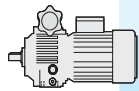
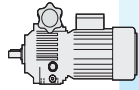
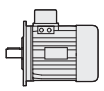

INDICE		INDEX	INHALTSVERZEICHNIS	
1.0	GENERALITA'	GENERAL INFORMATION	ALLGEMEINES	2
1.1	Unità di misura	<i>Measurement units</i>	Maßeinheiten	3
1.2	Potenza	<i>Power</i>	Leistung	3
1.3	Rapporto di riduzione	<i>Reduction Ratio</i>	Untersetzungsverhältnis	3
1.4	Momento torcente	<i>Torque</i>	Drehmoment	3
1.5	Fattore di servizio	<i>Service factor</i>	Betriebsfaktor	4
1.6	Rendimento	<i>Efficiency</i>	Wirkungsgrad	5
1.7	Irreversibilità	<i>Irreversibility</i>	Selbsthemmung	6
1.8	Gioco angolare	<i>Backlash</i>	Winkelspiel	7
1.9	Senso di rotazione	<i>Direction of rotation</i>	Drehrichtung	7
1.10	Carichi radiali	<i>Radial load</i>	Radialbelastungen	8
1.11	Potenza termica	<i>Thermal power</i>	Thermische Leistung	10
1.12	Selezione	<i>Selection</i>	Wahl	11
1.13	Lubrificazione	<i>Lubrication</i>	Schmierung	12
1.14	Installazione	<i>Installation</i>	Installation	13
1.15	Manutenzione	<i>Maintenance</i>	Wartung	14
1.16	Verniciatura	<i>Painting</i>	Lackierung	14
	2.0 RIDUTTORI A VITE SENZA FINE X	X WORM GEARBOXES	SCHNECKENGETRIEBE X	15
	3.0 RIDUTTORI A VITE SENZA FINE K	K WORM GEARBOXES	SCHNECKENGETRIEBE K	41
	4.0 RIDUTTORI A VITE SENZA FINE CON PRECOPIA H	H HELICAL WORM GEAR-BOXES	STIRNRAD-SCHNECKENGETRIEBE H	63
	5.0 RIDUTTORI A VITE SENZA FINE COMBINATI	COMBINED WORM GEAR-BOXES	DOPPEL-SCHNECKENGETRIEBE	85
	6.0 RIDUTTORI A VITE SENZA FINE CON DOPPIA USCITA	DOUBLE OUTPUT WORM GEARBOXES	SCHNECKENGETRIEBE MIT ZWEI AUSGANGSWELLEN	111
	7.0 VARIATORI N	VARIATORS N	VERSTELLGETRIEBE N	121
	8.0 VARIATORI UDL	VARIATORS UDL	VERSTELLGETRIEBE UDL	133
	9.0 MOTORI ELETTRICI	ELECTRIC MOTORS	ELEKTROMOTOREN	139

1.0 Generalità

TRAMEC si presenta oggi sul mercato con la nuova gamma di riduttori a vite senza fine con le seguenti serie:

1.0 General information

TRAMEC has introduced on the market a new range of worm gearboxes available as follows:

1.0 Allgemeines

TRAMEC hat auf dem Markt eine neue Auswahl an Schneckengetriebe aufgebracht:

Serie X

Riduttore a vite senza fine con corpo monolitico caratterizzato da una alta modularità di fissaggio grazie alla lavorazione in tolleranza di tutti i piani di appoggio.

Series X

Worm gearbox with monolithic body. Thanks to tolerance machining of all faces, the X series stands out for its high modularity of fastening options.

Serie X

Schneckengetriebe mit monolithischem Gehäuse. Dank der Bearbeitung mit Toleranz der Ablageflächen ist die X Serie durch die umfangreiche Modularität der Befestigungsmöglichkeiten gekennzeichnet.

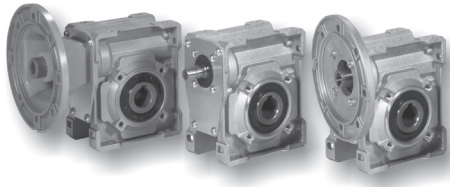

Serie K

Riduttori a vite senza fine con forma rotonda che consente ingombri e pesi inferiori. Svariate possibilità di versioni sono facilmente ottenibili anche grazie ai suoi particolari di collegamento (piedi e flange) che sono separati.

Series K

Worm gearboxes with round shape are light in weight and require reduced space. The coupling parts (feet and flanges) are separated and therefore offer the possibility to obtain countless versions.

Serie K

Schneckengetriebe in rundem Gehäuse weisen ein geringes Gewicht auf und benötigen weniger Platz. Die Anbauteile (Fuesse und Flansche) sind modular aufgebaut, wodurch viele unterschiedliche Versionen möglich sind.

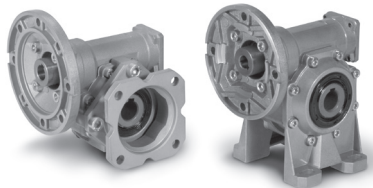

Serie H

Riduttore a vite senza fine con precoppia cilindrica con corpo monolitico. Si ottengono così rapporti più elevati conservando un buon rendimento.

Series H

Worm gearbox with cylindrical pre-stage module and single piece body. It offers higher ratios by maintaining a good efficiency.

Serie H

Schneckengetriebe mit zylindrischem Vorstufen-Modul und einteiligem Gehäuse. Es bietet höhere Untersetzungen bei gleichzeitig guter Effizienz.

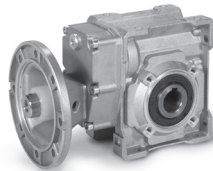

Serie KX - XX - KK

Riduttore combinato a doppia vite senza fine caratterizzato da elevate riduzioni di velocità.

KX - XX - KK Series

Worm gearbox with cylindrical pre-stage Combined worm gearbox with double worm shaft, it offers high speed reductions.

Serie KX - XX - KK

Kombinierte Doppelschneckengetriebe ermöglichen eine hohe Anzahl an Untersetzungsmöglichkeiten.

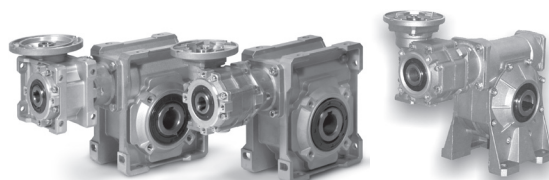

1.1 Unità di misura

1.1 Measurement units

1.1 Masseinheiten

Simbolo Symbol Symbol	Unità di misura Measurement unit Maßeinheit	Definizione	Definition	Beschreibung
FS'		Fattore di servizio riduttore	<i>Gearbox service factor</i>	Betriebsfaktor des Getriebes
FS		Fattore di servizio dell'applicazione	<i>Application service factor</i>	Betriebsfaktor der Anwendung
i_1		Rapporto di riduzione del 1° riduttore	<i>Ratio of 1st gearbox</i>	Untersetungsverhältnis des 1. Getriebes
i_2		Rapporto di riduzione del 2° riduttore	<i>Ratio of 2nd gearbox</i>	Untersetungsverhältnis des 2. Getriebes
i_n		Rapporto di riduzione	<i>Reduction ratio</i>	Untersetungsverhältnis
M_{2S}	[Nm]	Coppia di slittamento	<i>Slipping torque</i>	Rutschmoment
n_1	[min ⁻¹]	Giri in entrata	<i>Input speed</i>	Antriebsdrehzahl
n_2	[min ⁻¹]	Giri in uscita	<i>Output speed</i>	Abtriebsdrehzahl
P	[kW]	Potenza riduttore	<i>Gearbox capacity</i>	Getriebeleistung
P'	[kW]	Potenza richiesta in entrata	<i>Power required at input</i>	Erforderliche Leistung am Antrieb
P_1	[kW]	Potenza motoriduttore	<i>Gear motor power</i>	Getriebemotor Leistung
P_2	[kW]	Potenza in uscita	<i>Output power</i>	Abtriebsleistung
P_{1c}	[kW]	Potenza termica corretta	<i>Corrected thermal power</i>	verbesserte thermische Leistung
P_{10}	[kW]	Potenza termica nominale	<i>Thermal power</i>	Thermische Nennleistung
F_{r1}	[N]	Carico radiale albero entrata	<i>Input shaft radial load</i>	Radiallast an Antriebswelle
F_{r2}	[N]	Carico radiale albero uscita	<i>Output shaft radial load</i>	Radiallast an Abtriebswelle
F_{a1}	[N]	Carico assiale albero entrata	<i>Input shaft axial load</i>	Axiallast an Antriebswelle
F_{a2}	[N]	Carico assiale albero uscita	<i>Output shaft axial load</i>	Axiallast an Abtriebswelle
Rd		Rendimento dinamico	<i>Dynamic efficiency</i>	dynamischer Wirkungsgrad
Rs		Rendimento statico	<i>Static efficiency</i>	statischer Wirkungsgrad
Ta	[°C]	Temperatura ambiente	<i>Ambient temperature</i>	Umgebungstemperatur
T_{2M}	[Nm]	Momento torcente riduttore	<i>Gearbox torque</i>	Getriebe Drehmoment
T_2	[Nm]	Momento torcente motoriduttore	<i>Gear motor torque</i>	Getriebemotor Drehmoment
T_C	[Nm]	Momento torcente da utilizzare per la scelta del riduttore	<i>Torque to be used for the selection of the gearbox</i>	Drehmoment, das zur Wahl des Getriebe zu benutzen ist
T_2'	[Nm]	Momento torcente richiesto	<i>Required Torque</i>	benötigtes Drehmoment

1.2 Potenza

P = Potenza massima applicabile in entrata con vite ad albero maschio riferita alla velocità n_1 con un fattore di servizio FS = 1 e a un servizio continuo S1.

P_1 = Potenza motore consigliata riferita alla velocità n_1 con il fattore di servizio FS riportato in tabella a pag. 4 e a servizio continuo S1.

E' possibile determinare la potenza necessaria in entrata P' in base alla coppia T_2' richiesta all'applicazione secondo la seguente formula:

1.2 Power

P = max. power applicable at input with male worm shaft, referred to n_1 speed, service factor FS=1, on S1 continuous duty.

P_1 = recommended motor power, referred to n_1 speed, service factor FS as reported in the table on page 4, on S1 continuous duty.

The necessary input power with regard to T_2' torque required by the application, is to be calculated with the following formula:

$$P' = \frac{T_2' \cdot n_2}{9550 \cdot Rd} \quad [kW]$$

1.2 Leistung

P = am Antrieb max. anwendbare Leistung, mit Schneckenwellenzapfen bez. n_1 Antriebsdrehzahl, Betriebsfaktor FS=1 und S1 Dauerbetrieb.

P_1 = beratene Motorleistung bez. n_1 Drehzahl, FS Betriebsfaktor (wie es in der Tabelle auf Seite 4 angegeben wird) und S1 Dauerbetrieb.

Die am Antrieb erforderliche Leistung P' (auf Grund des von der Anwendung verlangten T_2' Drehmoments) kann wie folgt kalkuliert werden:

1.3 Rapporto di riduzione

i_n = È il rapporto di riduzione della velocità, definito come:

1.3 Reduction Ratio

i_n = speed reduction ratio, defined as follows:

$$i_n = \frac{n_1}{n_2}$$

1.3 Untersetungsverhältnis

i_n = Drehzahluntersetungsverhältnis, wird wie folgt definiert:

1.4 Momento torcente

T_{2M} = È la massima coppia trasmissibile in uscita del riduttore con carico uniforme riferito alla velocità n_1 con un fattore di servizio FS = 1 e a servizio continuo S1.

T_2 = È la coppia in uscita del motoriduttore riferita alla velocità n_1 alla potenza P_1 , con il fattore di servizio FS riportato in tabella e a servizio continuo S1.

1.4 Torque

T_{2M} = max. torque transmissible at gearbox output with uniform load, referred to n_1 speed, service factor FS = 1, on S1 continuous duty.

T_2 = output torque transmissible to the geared motor, referred to n_1 speed, P_1 power, FS service factor as reported in the table, on S1 continuous duty.

1.4 Drehmoment

T_{2M} = am Getriebeabtrieb max. übertragbaren Drehmoment, bei gleichmäßiger Last bez. n_1 Drehzahl, Betriebsfaktor FS = 1 und S1 Dauerbetrieb.

T_2 = übertragbares Abtriebsdrehmoment, bezogen auf die Antriebsdrehzahl n_1 , die Leistung P_1 und dem in der Tabelle angegebenen Betriebsfaktor FS bei Dauerbetrieb S1.

$$T_{2M} = \frac{9550 \cdot P_1 \cdot Rd}{n_2} \quad [Nm]$$

1.5 Fattore di servizio FS

È il valore che tiene in considerazione le varie condizioni di funzionamento:

- tipologia di applicazione ovvero natura del carico (A-B-C)
- durata di funzionamento (ore giornaliere h/gg)
- numero di avviamenti/ora

Il coefficiente così trovato (FS) dovrà essere uguale o inferiore al fattore di servizio del riduttore da adottare FS' dato dal rapporto tra la coppia T_{2M} indicata a catalogo e la coppia T_2 richiesta dall'applicazione.

1.5 FS Service factor

Value which takes the different operating conditions into consideration:

- type of application or type of load (A-B-C)
- length of operation (hours per day h/d)
- number of start-ups/hour

This coefficient (FS) will have to be equal or lower than the FS of selected gearbox FS' given by the ratio between T_{2M} torque mentioned in the catalogue and the T_2 torque required by the application.

1.5 Betriebsfaktor FS

Wert, der die verschiedenen Betriebsbedingungen in Betracht zieht:

- Art der Anwendung oder Art der Last (A-B-C)
- Betriebsdauer (Stunden pro Tag)
- Zahl der Starten pro Stunde

Der so berechnete Koeffizient (FS) muss kleiner oder gleich dem Betriebsfaktor FS' des Getriebes sein, welcher sich aus dem Verhältnis zwischen dem im Katalog angegebenen maximalen Drehmoment T_{2M} und dem von der Anwendung benötigten Drehmoment T_2 ergibt.

$$FS' = \frac{T_{2M}}{T_2} > FS$$

I valori di FS indicati in tabella sono relativi all'azionamento del motore elettrico; se utilizzato un motore a scoppio, si dovrà tenere conto di un fattore di moltiplicazione 1.3 se a più cilindri e 1.5 se monocilindrico. Se il motore elettrico applicato è autofrenante occorre considerare un numero di avviamenti doppio di quello effettivamente richiesto.

FS values reported in the table refer to the electric motor operation; should a combustion motor be used, consider a multiplication factor of 1.3 for a multicylinder motor, of 1.5 for a single-cylinder one. If an electric brake motor is used, consider a number of start-ups which is twice as much the number actually required.

Die in der Tabelle angegebenen FS Werte beziehen sich auf Anwendung eines Elektromotors. Falls einen Verbrennungsmotor verwendet wird, dann soll einen Multiplikationsfaktor von 1.3 für Mehrzylindermotor oder von 1.5 für Einzylindermotor in Betracht gezogen werden. Falls es sich um einen Elektro-Bremsmotor handelt, dann ist die Zahl der Starten doppelt zu zählen.

Classe di carico Load class Lastklasse	h/gg h/d St./Tag	N. AVVIAMENTI/ORA / N. START-UP/HOUR / ANZAHL DER STARTVORGÄNGE PRO STUNDE								
		2	4	8	16	32	63	125	250	500
A	4	0.8	0.8	0.9	0.9	1.0	1.1	1.1	1.2	1.2
	8	1.0	1.0	1.1	1.1	1.3	1.3	1.3	1.3	1.3
	16	1.3	1.3	1.3	1.3	1.5	1.5	1.5	1.5	1.5
	24	1.5	1.5	1.5	1.5	1.8	1.8	1.8	1.8	1.8
	APPLICAZIONI / APPLICATIONS / ANWENDUNGEN									
Agitatori per liquidi puri Alimentatori per fornaci Alimentatori a disco Filtri di lavaggio con aria Generatori Pompe centrifughe Trasportatori con carico uniforme			Pure liquid agitators Furnace feeders Disc feeders Air laundry filters Generators Centrifugal pumps Uniform load conveyors			Rührwerke für reine Flüssigkeiten Beschickungsvorrichtungen für Brennöfen Telleraufgeber Spülluftfilter Generatoren Kreiselpumpen Förderer mit gleichmäßig verteilter Last				
APPLICAZIONI / APPLICATIONS / ANWENDUNGEN										
B	4	1.0	1.0	1.0	1.0	1.3	1.3	1.3	1.3	1.3
	8	1.3	1.3	1.3	1.3	1.5	1.5	1.5	1.5	1.5
	16	1.5	1.5	1.5	1.5	1.8	1.8	1.8	1.8	1.8
	24	1.8	1.8	1.8	1.8	2.2	2.2	2.2	2.2	2.2
	APPLICAZIONI / APPLICATIONS / ANWENDUNGEN									
Agitatori per liquidi e solidi Alimentatori a nastro Argani con medio servizio Filtri con pietre e ghiaia Viti per espulsione acqua Flocculatori Filtri a vuoto Elevatori a tazze Gru			Liquid and solid agitators Belt conveyors Medium service winches Stone and gravel filters Dewatering screws Flocculator Vacuum filters Bucket elevators Cranes			Rührwerke für Flüssigkeiten und Feststoffe Bandförderer Mittlere Winden Filter mit Steinen/Kies Abwasserschnecken Flockvorrichtungen Vakuumfilter Becherwerke Kräne				
APPLICAZIONI / APPLICATIONS / ANWENDUNGEN										
C	4	1.3	1.3	1.3	1.3	1.5	1.5	1.5	1.5	1.5
	8	1.5	1.5	1.5	1.5	1.8	1.8	1.8	1.8	1.8
	16	1.8	1.8	1.8	1.8	2.2	2.2	2.2	2.2	2.2
	24	2.2	2.2	2.2	2.2	2.5	2.5	2.5	2.5	2.5
	APPLICAZIONI / APPLICATIONS / ANWENDUNGEN									
Argani per servizio pesante Estrusori Calandre per gomma Pressa per mattoni Piallatrici Mulini a sfera			Heavy duty hoists Extruders Crusher rubber calenders Brick presses Planing machine Ball mills			Winden für schwere Lasten Extruder Gummikalander Ziegelpressen Hobelmaschinen Kugelmühle				

1.6 Rendimento

Rd - È il rendimento dinamico, definito come rapporto tra la potenza in uscita P_2 e quella in entrata P_1 . Dipende principalmente dalla velocità di strisciamento, dal tipo di lubrificante e dall'angolo d'elica. I valori indicati nelle tabelle sono validi se si applica la corrispondente coppia in uscita. In fase di rodaggio, circa le prime 300 ore di funzionamento sotto carico, il valore deve essere considerato inferiore del 30% rispetto a quello indicato in tabella.

Rs - È il rendimento statico che si ha al momento dell'avviamento del riduttore e varia in base al rapporto di riduzione. Risulta importante, per una corretta valutazione del riduttore da impiegare, nelle applicazioni in cui non si raggiungono mai le condizioni di regime come nei funzionamenti intermittenti. Analogamente al caso dinamico, anche il rendimento statico durante il rodaggio risulta inferiore del 30% rispetto al valore indicato in tabella.

1.6 Efficiency

Rd - dynamic efficiency, defined as the ratio between P_2 output power and P_1 input power. It mainly depends on the slipping speed, the type of lubricant and the lead angle. The values reported in the table are valid when the corresponding output torque is applied. During the first 300 operating hours under load, the value to be considered is 30% lower than that reported in the table.

Rs - static efficiency at gearbox start-up; it changes depending on the reduction ratio. Rs value is important for selecting the right gearbox for applications where a steady state is never achieved, as for intermittent duty applications. Same as dynamic efficiency, static efficiency too during the running-in period will be 30% lower than the value reported in the table.

1.6 Wirkungsgrad

Rd - dynamischer Wirkungsgrad, ist das Verhältnis zwischen P_2 Abtriebsleistung und P_1 Antriebsleistung. Rd Wert wird durch Gleitgeschwindigkeit, Art des Schmiermittels und Steigungswinkel beeinflusst. Die Tabellen zeigen die Werte die gültig sind wenn das entsprechende Abtriebsdrehmoment gegeben ist. Während der Einlaufzeit in den ersten 300 Betriebsstunden unter Belastung, ist dieser Wert 30% niedriger als der in der Leistungstabelle angegebenen Wert.

Rs - statischer Wirkungsgrad beim Getriebebestart und in Abhängigkeit zur Unterersetzung. Der Wert Rs ist wichtig für die Auswahl des richtigen Getriebes für Anwendungen wo ein stetiger Betrieb nicht auftritt, wie bei Anwendungen mit Aussetzbetrieb. Der statischer Wirkungsgrad auch während der Einlaufzeit wird 30% niedriger als der in der Tabelle angegebenen Wert.

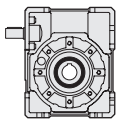

X - K	Rs											
	5	7.5	10	15	20	25	30	40	50	65	80	100
30	0.70	0.67	0.62	0.55	0.47	0.43	0.39	0.30	0.27	0.25	0.22	0.21
40	0.69	0.67	0.63	0.55	0.52	0.45	0.40	0.35	0.29	0.26	0.25	0.23
50	0.69	0.68	0.65	0.58	0.53	0.47	0.41	0.37	0.32	0.28	0.25	0.23
63	0.70	0.68	0.65	0.57	0.55	0.50	0.47	0.38	0.33	0.29	0.28	0.23
75	/	0.68	0.65	0.58	0.55	0.51	0.43	0.39	0.35	0.31	0.28	0.24
90	/	0.68	0.65	0.58	0.55	0.52	0.45	0.39	0.36	0.32	0.29	0.25
110	/	0.68	0.66	0.59	0.56	0.53	0.44	0.40	0.38	0.33	0.30	0.26
130	/	0.69	0.66	0.60	0.57	0.55	0.44	0.42	0.39	0.35	0.32	0.28

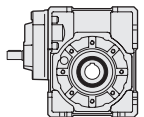

H	Rs										
	30	40	60	80	100	120	160	200	260	320	400
40	0.66	0.62	0.54	0.51	0.44	0.39	0.34	0.28	0.25	0.24	0.22
50	0.66	0.64	0.57	0.52	0.46	0.40	0.36	0.31	0.27	0.24	0.22
63	0.67	0.64	0.56	0.54	0.49	0.46	0.37	0.32	0.28	0.27	0.22
75	0.67	0.64	0.57	0.54	0.50	0.42	0.38	0.34	0.30	0.27	0.23
90	0.67	0.64	0.57	0.54	0.51	0.44	0.38	0.35	0.31	0.28	0.24
110	0.67	0.65	0.58	0.55	0.52	0.43	0.39	0.37	0.32	0.30	0.25
130	0.68	0.65	0.59	0.56	0.54	0.43	0.41	0.38	0.34	0.31	0.27

Stabilito il rapporto di riduzione necessario all'applicazione, dove è possibile, è consigliabile utilizzare i diversi tipi di riduttori che offrono, a parità di rapporto, un migliore rendimento dinamico.

Once the reduction ratio required by the application has been established, it is advisable to select a type of gearbox which, ratio being equal, offers better dynamic efficiency.

Nachdem das für die Anwendung erforderliche Untersetzungsverhältnis festgestellt worden ist, wählen Sie bei gleichem Untersetzungsverhältnis einen Getriebetyp, den einen besseren dynamischen Wirkungsgrad aufweist.

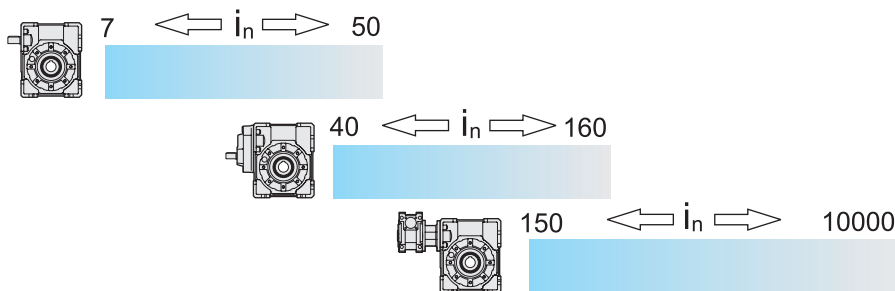

1.7 Irreversibilità

Nelle applicazioni dove è necessario evitare la trasmissione del moto retrogrado o sostenere il carico, in assenza di alimentazione elettrica, è consigliabile adottare freni esterni.

Nei riduttori a vite senza fine emerge questa caratteristica naturale, denominata grado di irreversibilità, che cresce con l'aumentare del rapporto di riduzione in quanto strettamente legata al relativo rendimento.

Per ottenere alti gradi di irreversibilità occorre quindi adottare i rapporti di riduzione più elevati, senza dimenticare che, il rendimento, tende a crescere durante le prime 500 ore di funzionamento per poi stabilizzarsi sui valori riportati a catalogo.

Irreversibilità statica

Condizione di impedimento alla rotazione comandata dall'albero lento senza escludere possibili ritorni lenti nel caso in cui il carico sia sottoposto a vibrazioni.

Rs < 0.45 si ha irreversibilità

Rs = 0.45 ÷ 0.55 irreversibilità incerta

Rs > 0.55 si ha reversibilità

Irreversibilità dinamica

Condizione di arresto e quindi di sostegno del carico nel momento in cui cessa l'azione di comando. La condizione è più difficile da ottenere in quanto viene influenzata dal rendimento dinamico, dalla velocità di rotazione, da eventuali vibrazioni che il carico può generare e dalla direzione del movimento rispetto al carico.

Quest'ultima condizione è molto evidente nei sollevamenti:

un carico in salita, cessando l'azione di comando, deve arrestarsi e quindi assumere velocità zero (rendimento statico) prima di invertire il moto e cadere per gravità.

Un carico in discesa tende invece a proseguire nel suo moto ostacolato, nella caduta, dal solo rendimento dinamico.

Rd < 0.45 si ha irreversibilità

Rd = 0.45 ÷ 0.55 irreversibilità incerta

Rd > 0.55 si ha reversibilità

1.7 Irreversibility

The use of external brakes is advised in case of applications where backwards motion must be hindered and the load must be held should the feed be cut off.

Some worm gearboxes feature natural irreversibility. The higher the ratio, the higher is the irreversibility, since it is strictly dependent on the relative efficiency.

In order to achieve high irreversibility it is therefore necessary to select higher efficiency reduction ratios not to forget that the efficiency is growing during the first 500 hours life until it stabilizes to the values mentioned in the catalogue.

Static irreversibility

Static irreversibility occurs when the rotation controlled by the output shaft is hindered; possible slow returns cannot be excluded should the load be subject to vibrations.

Rs < 0.45 provides irreversibility

Rs = 0.45 ÷ 0.55 irreversibility is uncertain

Rs > 0.55 reversibility is possible

Dynamic irreversibility

Dynamic irreversibility is characterized by stillstand and hold of the load when the drive stops.

It is more difficult to achieve this condition because it is influenced by dynamic efficiency, speed of rotation and possible vibrations generated by the motion direction with regard to the load.

This last condition is much more evident during the lifting: if the drive stops during the lifting of the load this has to come to a speed equals to zero (static irreversibility) before the reversal of motion rotation and its drop for gravity.

On the contrary the load during its descent gets its motion obstructed by its dynamic efficiency.

Rd < 0.45 provides irreversibility

Rd = 0.45 ÷ 0.55 irreversibility is uncertain

Rd > 0.55 reversibility is possible

1.7 Selbsthemmung

Aussenbremsen sind bei Anwendungen zu benutzen, bei denen Rückbewegung vermeiden werden muss oder die Last auch im Falle von Fehlen an Speisung gehalten werden muss.

Einige Schneckengetriebe sind selbsthemmend. Je höher die Untersetzung ist, desto höher ist die Selbsthemmung, da diese stark vom jeweiligen Wirkungsgrad abhängig ist. Um eine höhere Selbsthemmung zu erreichen, wählen Sie bitte höhere Untersetzungsverhältnisse.

Bitte beachten Sie, dass der Wirkungsgrad der Getriebe in den ersten 500 Betriebsstunden ansteigt und sich erst anschließend auf die im Katalog angegebenen Werte stabilisiert.

Statische Selbsthemmung

Statische Selbsthemmung liegt vor, wenn die von Abtriebswelle gesteuerten Drehung gehindert wird. Langsamer Rücklauf ist möglich, falls die Last Schwingungen ausgesetzt wird.

Rs < 0.45 es liegt Selbsthemmung vor

Rs = 0.45 ÷ 0.55 ungewisse Selbsthemmung

Rs > 0.55 es liegt Reversibilität vor

Dynamische Selbsthemmung

Stillstand und Stütze der Last beim Aussetzen der Steuerung.

Diese Bedingung ist schwieriger zu erreichen, da sie vom dynamischen Wirkungsgrad, der Drehzahl und von der Last verursachten möglichen Vibrationen abhängig ist

Dieser letzte Fall kommt bei Hubanwendungen stark zu tragen. Wenn der Antrieb während dem Hub stoppt, muss die Last eine Geschwindigkeit von annähernd null erreichen (statische Irreversibilität), bevor die Rotation sich umkehrt und die Last durch die Gravitation nach unten fährt. Dem entgegengesetzt bekommt die Last durch die Abwärtsbewegung Ihre dynamische Effizienz.

Rd < 0.45 es liegt Selbsthemmung vor

Rd = 0.45 ÷ 0.55 ungewisse Selbsthemmung

Rd > 0.55 es liegt Reversibilität vor

1.8 Gioco angolare

1.8 Backlash

1.8 Winkelspiel

X - K

i _n	30		40		50		63		75		90		110		130	
	min	max	min	max	min	max	min	max	min	max	min	max	min	max	min	max
5	10'	16'	9'	13.5'	7.5'	10.5'	7'	10'	/	/	/	/	/	/	/	/
7.5	10'	16'	9'	13.5'	7.5'	10.5'	7'	10'	7'	10'	6.5'	9.5'	6'	8'	6'	8'
10	10'	16'	9'	13.5'	7'	10.5'	7'	10'	7'	10'	6.5'	9'	6'	8'	6'	8'
15	10'	16'	9'	13.5'	7.5'	10.5'	7'	10'	7'	10'	6.5'	9'	6'	8'	6'	8'
20	9'	14.5'	7.5'	12'	6.5'	9.5'	6.5'	8.5'	6.5'	8.5'	6'	8.5'	6'	7'	6'	8'
25	9'	14.5'	7.5'	12'	6'	9.5'	6'	8.5'	6'	8.5'	6'	8.5'	5.5'	7'	5'	7'
30	9'	14.5'	7.5'	12'	6'	8.5'	6'	8.5'	6'	8.5'	6'	8.5'	5.5'	7'	5'	7'
40	9'	14.5'	7.5'	12'	6'	9.5'	6'	8.5'	6'	8.5'	6'	8'	5.5'	7'	5'	7'
50	8.5'	14'	7.5'	12'	6'	9.5'	6'	8.5'	6'	8.5'	6'	8'	5.5'	7'	5'	7'
65	8.5'	14'	7.5'	12'	6'	9'	6'	8'	6'	8'	6'	8'	5.5'	7'	5'	7'
80	8'	13.5'	7'	11.5'	6'	9'	5.5'	7.5'	5.5'	7.5'	5.5'	7.5'	5.5'	7'	5'	7'
100	8'	13'	7'	11'	6'	9'	5.5'	7.5'	5.5'	7.5'	5.5'	7.5'	5.5'	7'	5'	7'

H

i _n	40		50		63		75		90		110		130	
	min	max	min	max	min	max	min	max	min	max	min	max	min	max
30	12'	16.5'	10'	13.5'	9'	12'	9'	12'	8.5'	11.5'	7'	9'	7'	9'
40	12'	16.5'	10'	13.5'	9'	12'	9'	12'	8.5'	11'	7'	9'	7'	9'
60	12'	16.5'	10.5'	13.5'	9'	12'	9'	12'	8.5'	11'	7'	9'	7'	9'
80	10.5'	15'	9.5'	12.5'	8.5'	10.5'	8.5'	10.5'	8.5'	10.5'	7'	8'	7'	8'
100	10.5'	15'	9'	12.5'	8'	10.5'	8'	10.5'	8'	10.5'	6.5'	8'	6.5'	8'
120	12'	16.5'	10'	14.5'	8'	11.5'	9.5'	12'	8.5'	11'	7.5'	9'	6.5'	8'
160	10.5'	15'	9'	12.5'	8'	10.5'	8'	10.5'	8'	10.5'	6.5'	8'	6.5'	8'
200	10.5'	15'	9'	12.5'	8'	10.5'	8'	10.5'	8'	10'	6.5'	8'	6.5'	8'
260	10.5'	15'	9'	12.5'	8'	10.5'	8'	10.5'	8'	10'	6.5'	8'	6.5'	8'
320	10'	14.5'	9'	12'	7.5'	9.5'	7.5'	9.5'	7.5'	9.5'	6.5'	8'	6.5'	8'
400	10'	14'	9'	12'	7.5'	9.5'	7.5'	9.5'	7.5'	9.5'	6.5'	8'	6.5'	8'

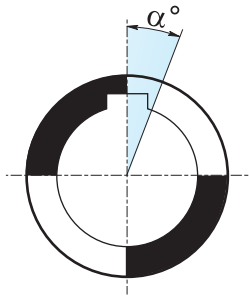

Misurato bloccando l'albero entrata, e ruotando l'albero uscita nelle due direzioni applicando la coppia strettamente necessaria a creare il contatto tra i denti degli ingranaggi, al massimo pari al 2% della coppia nominale (T_{2M}).

Angular backlash measured after having blocked the input shaft by rotating output shaft in both directions and applying the torque which is strictly necessary to create a contact between the teeth of the gears. The applied torque should be at most 2% of the max. torque (T_{2M}).

Nachdem die Antriebswelle blockiert worden ist, darf das Winkelspiel auf die Abtriebswelle bemessen werden. Dabei soll die Antriebswelle in beiden Richtungen gedreht werden und ein Drehmoment ausgeübt werden, das zur Entstehen eines Kontaktes zwischen den Zaehnen genuegt. Das ausgeübte Drehmoment soll höchstens 2% des max. von Getrieben garantierten Drehmoment (T_{2M}) sein.

1.9 Senso di rotazione

1.9 Direction of rotation

1.9 Drehrichtung

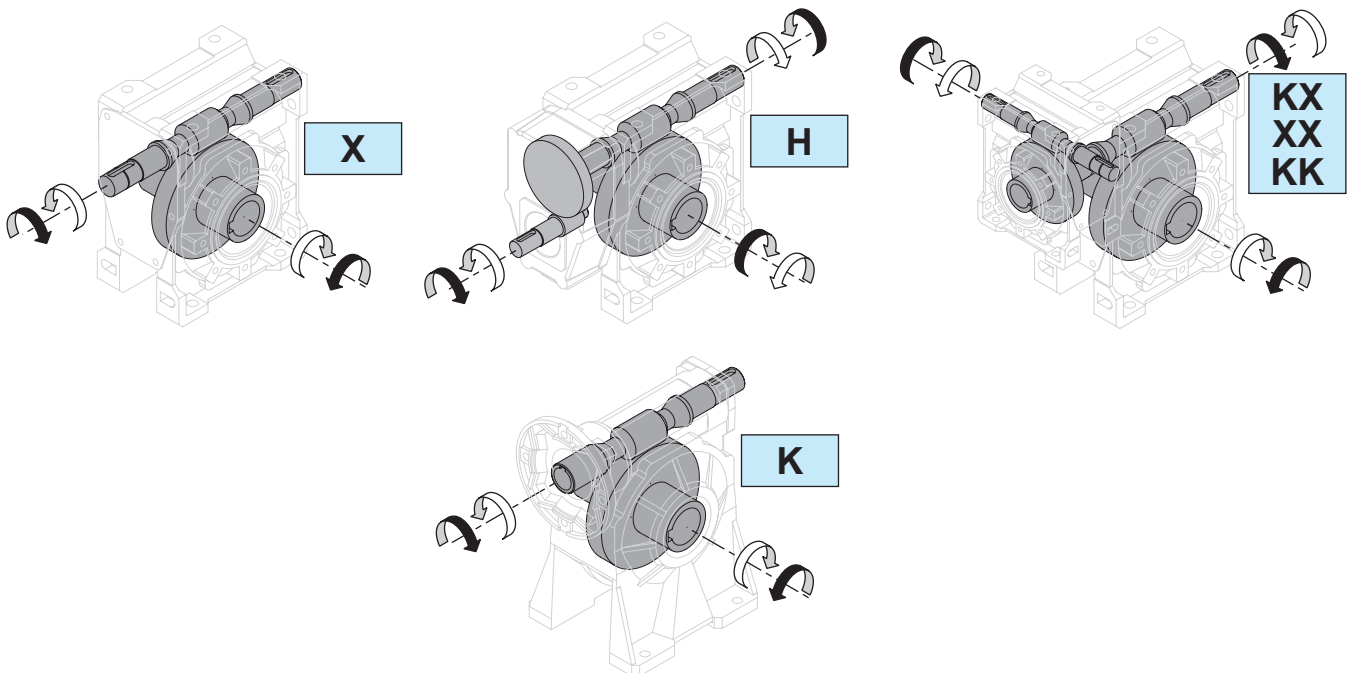

1.10 Carichi radiali

Ogni tipo di organo di trasmissione che viene collegato o sull'albero in entrata o in quello di uscita determina carichi radiali rispettivamente Fr_1 e Fr_2 .

I valori riportati in tabella in funzione delle varie velocità in entrata e in uscita sono da considerarsi applicabili come forza agente a metà della sporgenza; per un posizionamento a 1/3 della lunghezza occorre aumentare i valori di tabella del 25% mentre per un posizionamento a 2/3 della lunghezza occorre diminuire gli stessi valori del 25%.

I valori dei carichi assiali applicabili in entrata Fa_1 e in uscita Fa_2 sono indicati nelle tabelle.

Negli alberi bisporgenti, ogni estremità può sopportare un carico radiale pari ai 3/5 dei valori riportati in tabella purché agiscano nello stesso senso e siano di pari intensità

1.10 Radial load

Any transmission device coupled to either the input or to the output shaft generates radial loads, Fr_1 and Fr_2 respectively.

The load values reported in the table, depending on input and output speed, are to be considered as acting at the half-way point of the projection; if the load is applied at 1/3 of the projection, increase the values in the table by 25%; if the load is applied at 2/3, reduce the values by 25%.

Axial loads applicable at input Fa_1 and at output Fa_2 are reported in the tables.

With regard to double projecting shafts, each end can sustain a radial load which equals 3/5 of the values listed in the table, on condition that they act in the same direction and have the same intensity.

1.10 Radial Load

Antriebsorgane, die mit der Antriebs- oder Abtriebswelle verbunden werden, bewirken Radialbelastungen (Fr_1 und Fr_2 beziehungsweise).

Die in der Tabelle nach Antriebs- und Abtriebsdrehzahl angegebenen Werte beziehen sich auf Belastungen, die in der Mitte der herausragenden Welle wirken; falls die Belastungen auf 1/3 der Länge wirken, sollen die in der Tabelle angegebenen Werte um 25% erhöht werden; falls sie auf 2/3 der Länge wirken, sollen die Werte der Tabelle um 25% reduziert werden.

Die Werte der anwendbaren Axialbelastungen (Fa_1 am Antrieb und Fa_2 am Abtrieb) werden in den Tabellen angegeben. Bei doppelseitig herausragenden Wellen darf die Radialbelastung auf jedes Ende 3/5 der nachstehenden Werte betragen, unter die Bedingung dass Stärke und Richtung gleich sind.

Carichi radiali Fr_1 e assiali Fa_1 sull'albero entrata [N]

Fr_1 radial loads and Fa_1 axial loads on the input shaft [N]

Fr_1 Radialbelastungen und Fa_1 Axialbelastungen auf die Antriebswelle [N]

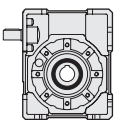
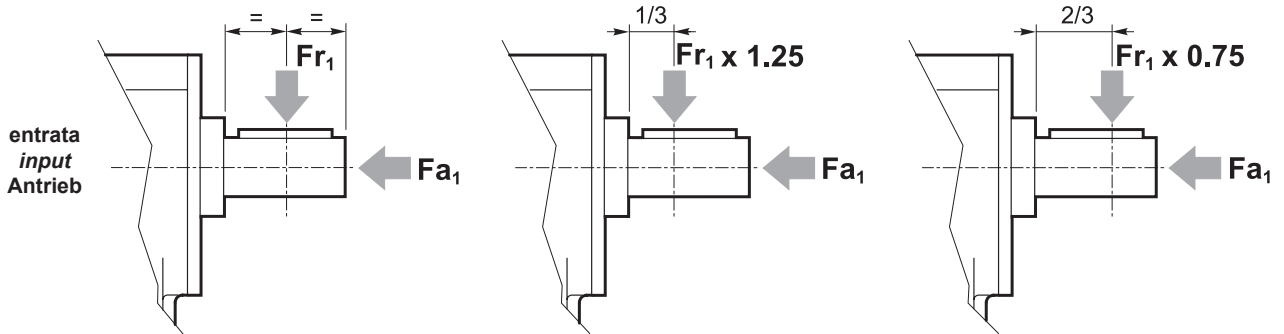

n_1 [min ⁻¹]	XA30		XA40		XA50		XA63		XA75		XA90		XA110		XA130	
	Fr_1	Fa_1	Fr_1	Fa_1	Fr_1	Fa_1	Fr_1	Fa_1	Fr_1	Fa_1	Fr_1	Fa_1	Fr_1	Fa_1	Fr_1	Fa_1
1400	100	20	220	44	400	80	480	96	750	150	850	170	1200	240	1500	300

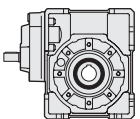

1400	HA40		HA50		HA63		HA75		HA90		HA110		HA130	
	Fr_1	Fa_1	Fr_1	Fa_1	Fr_1	Fa_1	Fr_1	Fa_1	Fr_1	Fa_1	Fr_1	Fa_1	Fr_1	Fa_1
	150	30	250	50	320	64	570	114	570	114	800	160	1000	200

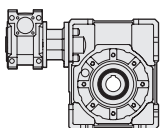

1400	XXA30/30 XXA30/40 XXA30/50 XXA30/63		XXA40/63 XXA40/75 XXA40/90		XXA50/75 XXA50/90 XXA50/110		XXA63/110		XXA63/130		-	
	Fr_1	Fa_1	Fr_1	Fa_1	Fr_1	Fa_1	Fr_1	Fa_1	Fr_1	Fa_1		
	100	20	220	44	400	80	480	96	480	96		

Carichi radiali Fr_2 e assiali Fa_2 sull'albero uscita [N]

Fr_2 radial loads and Fa_2 axial loads on the output shaft [N]

Fr_2 Radialbelastungen und Fa_2 Axialbelastungen auf die Abtriebswelle [N]

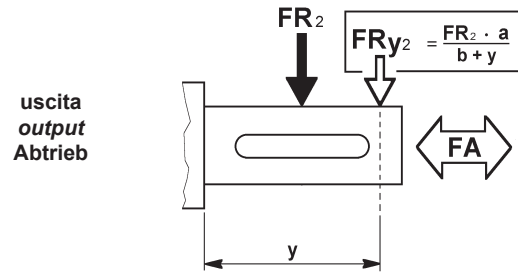

CUSCINETTI RADIALI A SFERE / RADIAL BALL BEARINGS / SCHRÄGKUGELLAGER																	
$n_1=1400$ rpm		30		40		50		63		75		90		110		130	
		30/30		30/40		30/50		30/63 40/63		40/75 50/75		40/90 50/90		50/110 63/110		63/130	
i_n	n_2 [rpm]	a = 66.5 b = 49		a = 83.5 b = 60.5		a = 102 b = 73.5		a = 122.5 b = 93.5		a = 134 b = 100		a = 163 b = 118		a = 179.5 b = 131.5		a = 190 b = 145	
		Fr_2	Fa_2	Fr_2	Fa_2	Fr_2	Fa_2	Fr_2	Fa_2	Fr_2	Fa_2	Fr_2	Fa_2	Fr_2	Fa_2	Fr_2	Fa_2
5	280	700	140	1400	280	1400	300	1800	360	/	/	/	/	/	/	/	/
7.5	187	750	150	1500	300	1650	330	2100	420	2500	500	2600	520	3500	700	5100	1020
10	140	800	160	1600	320	1800	360	2300	460	2800	560	3000	600	3800	760	5600	1120
15	93	850	170	1700	340	1950	390	2600	520	3000	600	3400	680	4200	840	6400	1280
20	70	900	180	1800	360	2200	440	2800	560	3300	660	3800	760	4600	920	7000	1400
25	56	950	190	1900	380	2400	480	3100	620	3700	740	4100	820	5100	1020	7600	1520
30	47	1000	200	2000	400	2600	520	3400	680	4000	800	4500	900	5600	1120	8050	1610
40	35	1050	210	2100	420	2850	570	3700	740	4400	880	4900	980	6100	1220	8800	1760
50	28	1100	220	2200	440	3100	620	4000	800	4850	970	5300	1060	6700	1340	9500	1900
60	23	1150	230	2400	480	3200	640	4200	840	5000	1000	5600	1120	7100	1420	9800	2000
63	22	1250	250	2500	500	3400	680	4450	890	5300	1060	5900	1180	7400	1480	10100	2020
80	17.5	1350	270	2700	540	3800	760	4900	980	5800	1160	6500	1300	8100	1620	11200	2240
100	14	1500	300	3000	600	4000	800	5400	1080	6500	1300	7000	1400	8500	1700	12050	2410
120	11.7	1520	304	3100	620	4100	820	5500	1100	6550	1310	7100	1420	8800	1760	12200	2500
150	9.3	1550	310	3150	630	4250	850	5600	1120	6600	1320	7300	1460	9100	1820	12500	2600
160	8.8	1570	314	3200	640	4300	860	5700	1140	6700	1340	7400	1480	9200	1840	12800	2650
≥ 200	≤ 7.0	1600	320	3300	660	4500	900	6000	1200	7100	1420	7900	1580	10000	2000	13000	2800

Versioni rinforzate

A richiesta vengono fornite versioni rinforzate con cuscinetti a rulli conici sulla corona in grado di sopportare carichi superiori rispetto a quelli ammessi nelle versioni normali con cuscinetti radiali a sfere. Essendo tali valori calcolati in funzione della durata dei cuscinetti, occorre valutare attentamente il tipo di versione più idoneo in modo da evitare problemi di tipo strutturale. In particolare, il carico assiale deve agire in modo da comprimere la flangia uscita.

I carichi assiali e radiali riportati in tabella non possono agire contemporaneamente nei loro valori massimi.

Nel caso di eventuale concorrenza delle due forze, queste devono essere limitate in rapporto al tipo di carico prevalente:

1. condizione di prevalenza del carico radiale:

Fr_2 = come a tabella
 Fa_2 = $Fr_2 \cdot 0.37$

Reinforced versions

The versions reinforced with tapered roller bearings on the worm wheel are available on request. They can bear higher loads compared to standard versions with radial ball bearings. These values are calculated in relation of the life of bearings therefore it is necessary to select the most suitable version in order to avoid any structural problem. In particular the axial load must compress the output flange.

The axial and radial loads shown in the table do not have to act simultaneously according to the max. values.

In case of concurrency of both forces these have to be reduced with regard to the prevailing type of load:

1. prevalence of radial load:

Fr_2 = as per table
 Fa_2 = $Fr_2 \cdot 0.37$

Versionen mit Kegelrollenlager

Auf Wunsch können Versionen mit Kegelrollenlager auf dem Schneckenrad geliefert werden. Sie erlauben höheren Lasten in Vergleich zu den Standardprodukten mit Schrägkugellagern. Diese Werte sind entsprechend der Lebensdauer der Lager berechnet. Daher ist es erforderlich, die am besten passende Ausführung zu wählen, um Probleme zu vermeiden. Auf alle Fälle muss die Axialbelastung den Abtriebsflansch zusammendrücken.

Die in der Tabelle angegebenen Maximalwerte der Axial - und Radialbelastung sollten nicht gleichzeitig auftreten.

Falls Axial- und Radialbelastungen auftreten, sollte jene Belastungsrichtung zur Auswahl herangezogen werden, die vom Anteil überwiegt:

1. radialbelastungen überwiegen:

Fr_2 = siehe Tabelle
 Fa_2 = $Fr_2 \cdot 0.37$

2. condizione di prevalenza del carico assiale:

$$Fa_2' = Fa_2 \cdot 0.6$$

$$Fr_2' = Fa_2 \cdot 0.4$$

2. prevalence of axial load:

$$Fa_2' = Fa_2 \cdot 0.6$$

$$Fr_2' = Fa_2 \cdot 0.4$$

2. Axialbelastungen überwiegen

$$Fa_2' = Fa_2 \cdot 0.6$$

$$Fr_2' = Fa_2 \cdot 0.4$$

CUSCINETTI A RULLI CONICI / TAPERED ROLLER BEARINGS / KEGELROLLENLAGER																	
n ₁ =1400 rpm		30		40		50		63		75		90		110		130	
		30/30		30/40		30/50		30/63 40/63		40/75 50/75		40/90 50/90		50/110 63/110		63/130	
i _n	n ₂ [rpm]	a = 61.4 b = 43.9		a = 77 b = 54		a = 94.5 b = 66		a = 114.8 b = 85.8		a = 123.8 b = 89.8		a = 152.8 b = 107.8		a = 167.3 b = 119.3		a = 174.8 b = 129.8	
		Fr ₂	Fa ₂	Fr ₂	Fa ₂	Fr ₂	Fa ₂	Fr ₂	Fa ₂	Fr ₂	Fa ₂	Fr ₂	Fa ₂	Fr ₂	Fa ₂	Fr ₂	Fa ₂
5	280	800	1100	1800	2300	4000	5000	4000	5000	/	/	/	/	/	/	/	/
7.5	187	900	1200	1900	2400	4500	5500	4500	5500	5300	6500	6000	8000	8000	10500	9500	11000
10	140	1000	1300	2000	2500	5000	6000	5000	6000	5500	6700	7000	9200	8300	11000	10500	12500
15	93	1100	1400	2100	2600	5800	7000	5800	7000	5700	6900	7400	9800	8800	11500	11000	13000
20	70	1250	1650	2300	2800	6000	7200	6100	7300	6400	7600	7800	10300	9300	12000	15000	13500
25	56	1450	1900	2500	3000	6200	7500	6500	7700	7400	9400	8500	11000	9800	12500	12000	14000
30	47	1700	2200	2800	3300	6500	7800	6800	8000	8000	10000	9500	12000	10500	13200	12500	14000
40	35	1800	2300	3000	3500	6600	8000	7000	8200	8500	10500	10000	12500	11000	14000	14000	16000
50	28	1900	2400	3200	3700	6800	8200	7100	8400	9000	11000	10500	13000	12000	15000	14500	17000
60	23	1900	2400	3200	3700	6800	8200	7100	8400	9000	11000	10500	13000	12000	15000	15000	17000
63	22	1900	2400	3200	3700	6800	8200	7100	8400	9000	11000	10500	13000	12000	15000	15000	17000
80	17.5	1900	2400	3200	3700	6800	8200	7100	8400	9000	11000	10500	13000	12000	15000	15000	17000
100	14	1900	2400	3200	3700	6800	8200	7100	8400	9000	11000	10500	13000	12000	15000	15000	17000
120	11.7	1900	2400	3200	3700	6800	8200	7100	8400	9000	11000	10500	13000	12000	15000	15000	17000
150	9.3	1900	2400	3200	3700	6800	8200	7100	8400	9000	11000	10500	13000	12000	15000	15000	17000
160	8.8	1900	2400	3200	3700	6800	8200	7100	8400	9000	11000	10500	13000	12000	15000	15000	17000
≥ 200	≤ 7.0	1900	2400	3200	3700	6800	8200	7100	8400	9000	11000	10500	13000	12000	15000	15000	17000
Cuscinetto Bearing Lager		32005 25x47x15		32006 30x55x17		32008 40x68x19		32008 40x68x19		32010 50x80x20		32010 50x80x20		32012 60x95x23		32015 75x115x25	

1.11 Potenza termica

Nelle tabelle riportate nelle sezioni relative ad ogni tipologia di riduttore sono indicati i valori della potenza termica nominale P_{t0} [kW]. Tale valore rappresenta la potenza massima applicabile all'entrata del riduttore, in servizio continuo a temperatura massima ambiente di 30°C, così che la temperatura dell'olio non oltrepassi il valore di 95°C.

Il valore di P_{t0} non deve essere preso in considerazione se il funzionamento è continuo per un massimo di 1 - 2 ore seguito da pause di durata sufficiente (circa 2 ore) a ristabilire nel riduttore la temperatura ambiente.

I valori di P_{t0} devono essere corretti tramite i seguenti coefficienti, così da considerare le reali condizioni di funzionamento, ottenendo i valori di potenza termica corretta P_{tc}.

1.11 Thermal power

The sections dedicated to each type of gearbox contain tables reporting the values of P_{t0} rated thermal power (kW). Listed values represent the max. power applicable at gearbox input, on continuous duty and at an ambient temperature of max. 30°C, so that oil temperature does not exceed 95°C.

P_{t0} value is not to be taken into account if duty is continuous for max. 1 - 2 hours and followed by breaks which are long enough to bring the gearbox back to ambient temperature (roughly 2 hours). In order to take the actual operating conditions into account, P_{t0} values have to be corrected with the following coefficients, thus obtaining the values of P_{tc} corrected thermal power.

1.11 Thermische Leistung

Für jeden Getriebetyp werden in den relativen Kapiteln die Nennwerte der P_{t0} thermischen Leistung angegeben [kW]. Diese Werte entsprechen der max. übertragbaren Antriebsleistung am Getriebe in Dauerbetrieb mit max. Umgebungstemperatur von 30°C, sodass die Öltemperatur unter 95°C bleibt.

P_{t0} Wert ist nicht zu beachten, falls Dauerbetrieb max. 1 - 2 Stunden dauert und von Unterbrechungen gefolgt wird, die lang genug sind, damit das Getriebe-temperatur zurück zur Umgebungstemperatur sinkt (ungefähr 2 Stunden).

P_{t0} Werte sollen durch die folgenden Koeffizienten verbessert werden, damit die reelle Betriebsbedingungen wirklich in Betracht gezogen werden. Mit der folgenden Formel erhält man die Werte der korrekte thermische Leistung P_{tc}.

$$P_{tc} = P_{t0} \cdot ft \cdot fv \cdot fu \quad [\text{kW}]$$

Dove:

ft = coefficiente di temperatura ambiente
fv = coefficiente di ventilazione
fu = coefficiente di utilizzo

Where:

ft = environment temperature coefficient
fv = ventilation coefficient
fu = utilization coefficient

Dabei ist:

ft = Umwelt Temperaturkoeffizient
fv = Luftkühlungskoeffizient
fu = Anwendungskoeffizient

I coefficienti di correzione sono ricavabili dalle seguenti tabelle:

Corrective coefficients are shown in the following tables:

Verbesserungskoeffizienten sind aus der nachstehenden Tabelle zu entnehmen:

Ta (°C)	0	5	10	15	20	25	30	35	40	45	50
ft	1.46	1.38	1.31	1.23	1.15	1.1	1.0	0.92	0.85	0.77	0.69

Ta = Temperatura ambiente (°C)

Ta = ambient temperature (°C)

Ta = Umgebungstemperatur (°C)

fv = 1.45 con ventilazione forzata efficace con ventola dedicata

fv = 1.45 for forced ventilation with specific fan

fv = 1.45 bei Drucklüftung mit spezifischem Lüfterrad

fv = 1.25 con ventilazione forzata secondaria ad altri dispositivi (pulegge, ventole, motore, ecc.)

fv = 1.25 for forced ventilation secondary to other devices (pulleys, fans, motor, etc.)

fv = 1.25 bei Drucklüftung nebensächlich anderen Vorrichtungen (Scheiben, Lüfterräder, Motor, usw.)

fv = 1 refrigerazione naturale (situazione standard)

fv = 1 for natural cooling (standard situation)

fv = 1 natürliche Belüftung (Standard)

fv = 0.5 in ambiente chiuso e ristretto (carter)

fv = 0.5 in a close and narrow environment (case)

fv = 0.5 in engem und geschlossenem Raum (Gehäuse)

Dt (min)	10	20	30	40	50	60
fu	1.6	1.35	1.2	1.1	1.05	1

Dt = minuti di funzionamento in un'ora

Dt = minutes of operation per hour

Dt = Betriebsminuten pro Stunde

1.12 Selezione

1.12 Selection

1.12 Wahl

Scelta del riduttore

Selecting a gearbox

Wahl des Getriebes

A) n₁ = 1400, 2800, 900, 500 min⁻¹

Si sceglierà nelle tabelle delle prestazioni dei riduttori un gruppo che in corrispondenza di un rapporto prossimo a quello calcolato ammetta una potenza:

A) n₁ = 1400, 2800, 900, 500 min⁻¹

Consult the gearbox unit efficiency table; select a group whose ratio is close to the calculated ratio and which permits power:

A) n₁ = 1400, 2800, 900, 500 min⁻¹

Aus der Leistungstabellen ist eine Gruppe von Getrieben zu wählen, deren Übersetzungsverhältnis nahe zu dem berechneten Wert ist und die die folgende Leistung erlaubt:

$$P \geq P' \cdot FS'$$

Scelta del motoriduttore

Selecting a gearmotor

Wahl des Getriebemotors

B) FS =1

Si cercherà nelle tabelle delle prestazioni dei motoriduttori un gruppo la cui potenza P1 corrisponda alla P' calcolata.

B) FS =1

Consult the gear motor efficiency table and select a group having power P1 corresponding to calculated P'.

B) FS =1

Wählen Sie aus der Leistungstabelle der motoren eine Gruppe, deren Leistung P1 der berechneten Leistung P' entspricht.

C) FS ≠1

La scelta dovrà essere effettuata come al punto A) verificando che la grandezza del motore da installare sia compatibile con quelle ammesse dal riduttore (IEC); ovviamente la potenza installata dovrà corrispondere al valore P' richiesto.

C) FS ≠1

Follow the instructions at point A), checking that the size of the motor to be installed is compatible with the gearbox unit (IEC); obviously, installed power must correspond to the required P' value.

C) FS ≠1

Folgen Sie die Weisungen unter A). Es ist zu prüfen, dass die Größe des zu installierenden Motor mit dem Getriebe kompatibel ist (IEC); die installierte Leistung soll dem erforderlichen P' Wert entsprechen.

Determinato il riduttore idoneo è necessario verificare che anche gli eventuali carichi aggiuntivi (radiali ed assiali) agenti sugli alberi in uscita e/o entrata rientrino nei valori ammissibili dati a catalogo.

In determinate condizioni applicative può diventare necessario verificare che la potenza assorbita dal riduttore non superi quella del limite termico riportata a catalogo, secondo quanto riportato al punto 1.10 relativamente alla potenza termica.

After having selected the proper gearbox, it is necessary to check out that possible additional loads (radial or axial) on the input and/or output shafts fall within the values reported in the catalogue.

Depending on the application, it might be necessary to check that the power absorbed by the gearbox does not exceed the thermal power limit reported in the catalogue as per paragraph 1.10.

Nachdem das geeignete Getriebe gewählt worden ist, muss es sichergestellt werden, dass zusätzlichen Radial-oder Axialbelastungen auf die Antriebs-oder Abtriebswelle unter den im Katalog gegebenen Werten fallen.

Abhängig von der Art der Anwendung ist es manchmal zu prüfen, dass die von Getriebe absorbierten Leistung unter der Wert der thermischen Leistung liegt, wie es in dem Katalog angegeben wird (Abschnitt 1.10).

1.13 Lubrificazione

Tutti i riduttori, eccetto X130 e K130, sono forniti completi di lubrificante sintetico a base PAG con indice di viscosità ISO VG320.

I cuscinetti dell'albero veloce vengono sempre lubrificati con grasso a base sintetica; altri cuscinetti vengono lubrificati solo se la posizione di montaggio non ne garantisce la corretta lubrificazione.

Una scelta oculata del tipo di lubrificante, in funzione delle condizioni operative e ambientali, consente ai riduttori di raggiungere le prestazioni ottimali.

Le prestazioni dei riduttori indicate nelle tabelle dei dati tecnici sono state calcolate considerando l'impiego di olio sintetico.

VISCOSITA'

E'uno dei parametri più importanti da considerare nella scelta di un olio ed è influenzabile da diversi parametri quali velocità, temperatura. Riportiamo sinteticamente le valutazioni generali per la scelta della giusta viscosità:

Viscosità alta

Usare per basse velocità di rotazione e/o temperature alte.
(Una viscosità troppo bassa in queste condizioni operative causa una usura precoce).

Viscosità bassa

Usare per alte velocità di rotazione e/o temperature basse.
(Una viscosità troppo elevata provoca diminuzione del rendimento e surriscaldamento).

ADDITIVI

In tutti gli oli minerali sono contenuti degli additivi antiusura, EP (più o meno energici), antiossidanti ed antischiuma. E' opportuno assicurarsi che essi siano blandi e non aggressivi nei confronti delle guarnizioni.

BASE DELL'OLIO

Può essere minerale o sintetica.
L'olio sintetico, compensa il costo più elevato con una serie di vantaggi:

- a) minor coefficiente d'attrito (quindi migliore rendimento)
- b) migliore stabilità nel tempo (possibile lubrificazione a vita)
- c) migliore indice di viscosità (migliore adattabilità alle varie temperature).

L'olio a base minerale come vantaggi ha il minore costo e un migliore comportamento in rodaggio.

1.13 Lubrication

All worm gearboxes, except for the type X130 and K130, are supplied with synthetic lubricant, PAG base, viscosity index ISO VG 320.

The bearings mounted on the input shaft are supplied with grease, synthetic base; the other bearings are lubricated only if the mounting position does not assure a correct lubrication.

Choose the lubricant according to operating and ambient conditions in order to ensure high gear unit performance.

Performance data, as shown in the specifications tables, refer to utilization of synthetic oil.

VISCOSITY

It is one of the most important parameters to be considered when selecting an oil; it depends on various factors such as speed and temperature. Following are general guidelines for choosing the correct viscosity:

High viscosity

*To be used for low rotation speed and/or high temperatures.
(Under these operating conditions a low viscosity causes premature wear).*

Low viscosity

*To be used for high rotation speed and/or low temperatures.
(High viscosity reduces efficiency and causes overheating).*

ADDITIVES

All mineral oils contain additives to protect against wear, EP (more or less strong), anti-oxidizing and anti-frothing. It is advisable to make sure that the action of such additives is bland and not too aggressive on the seals.

OIL BASE

*May be mineral or synthetic.
Synthetic oil compensates for the higher cost with a series of advantages :*

- a) *lower friction coefficient (consequently improved efficiency)*
- b) *better stability over time (possible life lubrication)*
- c) *better viscosity index (more adaptable to various temperatures).*

Mineral-base oils offer the advantages of costing less and performing better during the running-in period.

1.13 Schmierung

Alle Schneckenradgetriebe mit Ausnahme der Ausführung X130 und K130, werden mit synthetischem Schmiermittel auf PAG Basis und Viskosität Index ISO VG 320 geliefert.

Die Kugellager auf der Eingangswelle sind immer mit synthetischem Fett geliefert. Falls die Montage keine korrekte Schmierung versichert, dann sind die restlichen Lager mit Schmiermittel geliefert.

Das Untersetzungsgetriebe wird optimal arbeiten, wenn das richtige Schmiermittel je nach Betriebs- und Umgebungsbedingungen sorgfältig ausgewählt wird.

Daten über Getriebeleistung, wie es in den Tabellen der technischen Daten angegeben wird, beziehen sich auf Schmierung mit synthetischem Öl.

VISKOSITÄT

Die Viskosität ist eins der wichtigsten Merkmale, die bei der Auswahl des richtigen Öls zu beachten sind; sie wird von verschiedenen Parametern wie Geschwindigkeit und Temperatur beeinflusst. Im folgenden fassen wir die wichtigsten allgemeinen Hinweise für die Wahl der richtigen Viskosität zusammen:

Hohe Viskosität

Geeignet für niedrige Drehzahlen bzw. hohe Temperaturen. (Eine zu geringe Viskosität verursacht unter diesen Betriebsbedingungen frühen Verschleiß).

Geringe Viskosität

Geeignet für hohe Drehzahlen bzw. niedrige Temperaturen.
(Eine zu geringe Viskosität verursacht unter diesem Fall zu einer Verringerung des Wirkungsgrades und zur Überhitzung).

ZUSÄTZE















Alle Mineralöle enthalten Antiverschleißzusätze, EP (mehr oder weniger stark), Oxydationsschutzmittel und Schaumverhinderungs-Wirkstoffe. Es soll sichergestellt werden, daß diese Zusätze schwach sind und die Dichtungen nicht angreifen.

ÖLGRUNDLAGE

Es kann sich dabei um Mineralöl oder synthetisches Öl handeln.
Synthetisches Öl ist zwar teurer, bietet jedoch eine Reihe von Vorteilen:

- a) geringerer Reibungskoeffizient (demnach besserer Wirkungsgrad)
- b) bessere Stabilität über lange Zeit (lebenslange Schmierung möglich)
- c) besserer Viskositätsindex (paßt sich besser an verschiedene Temperaturen an).

Die Vorteile von Mineralöl sind die geringeren Kosten und das bessere Einfahrverhalten.

ISO VG	OLIO MINERALE / MINERAL OIL / MINERALÖL			OLIO SINTETICO / SYNTHETIC OIL / SYNTETISCHES ÖL					
	460	320	220	460	320	220	150		
Temperatura ambiente Amb. Temp. Ta (°C) Umgebungstemperatur	5° a 45°	0° a 40°	-5° a 35°	-15° a 100°	-20 a 90°	-25° a 80°	-30° a 70°		
FORNITORE / MANUFACTURER / HERSTELLER	MINERALE / MINERAL / MINERAL								
	SHELL		Omala OIL 460	Omala OIL 320	Omala OIL 220				
	BP		Energol GRXP 460	Energol GRXP 320	Energol GRXP 220				
	TEXACO		Meropa 460	Meropa 320	Meropa 220				
	CASTROL		Alpha SP 460	Alpha SP 320	Alpha SP 220				
	KLUBER		Lamora 460	Lamora 320	Lamora 220				
	MOBIL		Mobilgear 634	Mobilgear 632	Mobilgear 630				
	Tecnologia PAG (polialcoliglicoli) / PAG Technology (polyalkyleneglycol) / PAG (Polyalkylglykole)								
	SHELL					Omala S4 WE 460	Omala S4 WE 320	Omala S4 WE 220	Omala S4 WE 150
	BP					Energol SGXP460	Energol SGXP320	Energol SGXP220	Enersyn SG 150
	TEXACO					Synlube CLP 460	Synlube CLP 320	Synlube CLP 220	
	AGIP						Agip Blasias S 320	Agip Blasias S 220	Agip Blasias S 150
	Tecnologia PAO (polialcoliolefini) / PAO Technology (polyalphaolefin) / PAO (Polyalphaolefine)								
	SHELL					Omala OIL RL/HD 460	Omala OIL RL/HD 320	Omala OIL RL/HD 220	Omala OIL RL/HD 150
	CASTROL					Alpha Synt 460	Alpha Synt 320	Alpha Synt 220	Alpha Synt 150
	KLUBER					Synteso D460 EP	Synteso D320 EP	Synteso D220 EP	Synteso D150 EP
MOBIL					SHC 634	SHC 632	SHC 630	SHC 629	

1.14 Installazione

Fissare il riduttore in modo tale da evitare qualsiasi vibrazione e curare l'allineamento del riduttore con il motore e l'utenza utilizzando, quando è possibile, giunti di accoppiamento.

Assicurarsi che gli organi da montare sui riduttori abbiano le tolleranze ISO h6 per gli alberi e ISO H7 per i fori.

Se il riduttore viene installato all'aperto si consiglia l'utilizzo del tappo di sfiato con valvola, tranne le grandezze 30-40-50-63-75.

Tutti i riduttori e motoriduttori citati nel presente manuale sono destinati ad un impiego industriale con temperatura ambiente da -20°C a +40°C ad una altitudine max di 1000 m slm.

Per tutte le altre avvertenze consultare il manuale di "uso e manutenzione" scaricabile dal sito www.tramec.it

1.14 Installation

The gearbox has to be mounted to prevent any vibration. Check carefully the alignment gearbox / motor / machine and use couplings whenever possible. Check that devices to be mounted on the gearbox feature ISO h6 tolerance for the shafts and ISO H7 for the holes.

If the gearbox is installed outdoors, we recommend the use of the breather plug with valve, except size 30-40-50-63-75.

All reducers and gear motors mentioned in this catalog are intended for industrial use and operation at a ambient temperature between -20°C and +40°C, at an altitude of max. 1000 m above sea level.

For all other instructions check the "Use and Maintenance Manual" which can be downloaded from our web site www.tramec.it

1.14 Installation

Das Getriebe ist so zu installieren, dass allerart Schwingung vorbeugt wird. Auf die Fluchtung Getriebe / Motor / Maschine ist es besonders achtzugeben. Dabei sind Kupplungen womöglich zu benutzen. Die auf dem Getriebe montierten Elemente sollen die folgende Toleranz aufweisen: ISO h6 für die Wellen und ISO h7 für die Bohrungen.

Abgesehen von Größen 30-40-50-63-75, die Anwendung einer Entlüftungsschraube mit Ventil wird empfohlen, wenn das Getriebe im Freien eingebaut wird.

Alle im vorliegenden Katalog angegebenen Getriebe und Getriebemotoren sind für industriellen Einsatz in einer Umgebungstemperatur von -20°C bis +40°C und in einer max. Höhe von 1000 m über dem Meeresspiegel vorgesehen.

Für weitere Anweisungen laden Sie die "Betriebs- und Instandhaltungsanweisung" aus unsere Webseite www.tramec.it herunter.

1.15 Manutenzione

Tutti i riduttori a vite senza fine, eccetto X130 e K130, sono lubrificati a vita con olio sintetico tipo SHELL OMALA S4 WE 320.

Non necessitano quindi di particolari manutenzioni se non il mantenimento della pulizia esterna, evitando l'uso di solventi per non danneggiare guarnizioni o anelli di tenuta, ed il rispetto di tutte le indicazioni e della eventuale sostituzione dell'olio negli intervalli programmati e riportati nel manuale di "uso e manutenzione" scaricabile dal sito www.tramec.it

1.15 Maintenance

All worm gearboxes, except for the type X130 and K130, are lubricated for life with synthetic oil SHELL OMALA S4 WE 320. For this reason they do not require any particular maintenance, except for external cleaning (avoid the use of solvents which might damage gaskets and oil seals) and observance of the schedules for oil change as reported in the "Use and Maintenance Manual" which can be downloaded from our web site www.tramec.it

1.15 Wartung

Alle Schneckengetriebe mit Ausnahme der Ausführung X130 und K130 sind mit synthetischem Öl SHELL OMALA S4 WE 320 lebenslang geschmiert.

Deshalb brauchen sie kein besonderes Instandhalten außer Aussenreinigung und Befolgung der Zeitabstände für Ölwechsel, wie es in der "Betriebs- und Instandhaltungsanweisung" auf unsere Webseite www.tramec.it angegeben wird. Bei der Aussenreinigung benutzen Sie keine Lösemittel, weil sie die Dichtungen beschädigen.

1.16 Verniciatura

Le carcasse in ghisa e le flange delle grandezze 90, 110 e 130 sono verniciate di colore BLU RAL 5010 mentre quelle in alluminio delle grandezze 75, 63, 50, 40 e 30 sono sabbiato.

1.16 Painting

Size 90, 110 and 130 have cast iron housings and flanges painted BLUE RAL 5010. The housings of sizes 75, 63, 50, 40 and 30 are made in aluminium and sandblasted.

1.16 Lackierung

Die Gehäuse der Größen 90, 110 und 130 bestehen aus Gusseisen und sind BLAU RAL 5010 lackiert.

Für Größen 75, 63, 50, 40 und 30 ist das Gehäuse aus Aluminium und sandgestrahlt.

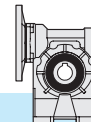

3.0	RIDUTTORE A VITE SENZA FINE SERIE K	K WORM GEARBOXES	SCHNECKENGETRIEBE K	
3.1	Caratteristiche	<i>Characteristics</i>	Merkmale	42
3.2	Designazione	<i>Designation</i>	Bezeichnung	43
3.3	Lubrificazione e posizioni di montaggio	<i>Lubrication and mounting position</i>	Schmierung und Einbaulage	43
3.4	Posizione morsettiera	<i>Terminal board position</i>	Lage des Klemmenbrett	43
3.5	Dati tecnici	<i>Technical data</i>	Technische Daten	43
3.6	Momenti d'inerzia	<i>Moments of inertia</i>	Trägheitsmoment	54
3.7	Dimensioni	<i>Dimensions</i>	Abmessungen	56
3.8	Entrata supplementare	<i>Additional input</i>	Zusatzantrieb	59
3.9	Limitatore di coppia cavo passante	<i>Torque limiter with through hollow shaft</i>	Drehmomentbegrenzer mit durchgehender Hohlwelle	59
3.10	Accessori	<i>Accessories</i>	Zubehör	61
3.11	Lista parti di ricambio	<i>Spare parts list</i>	Ersatzteilliste	62

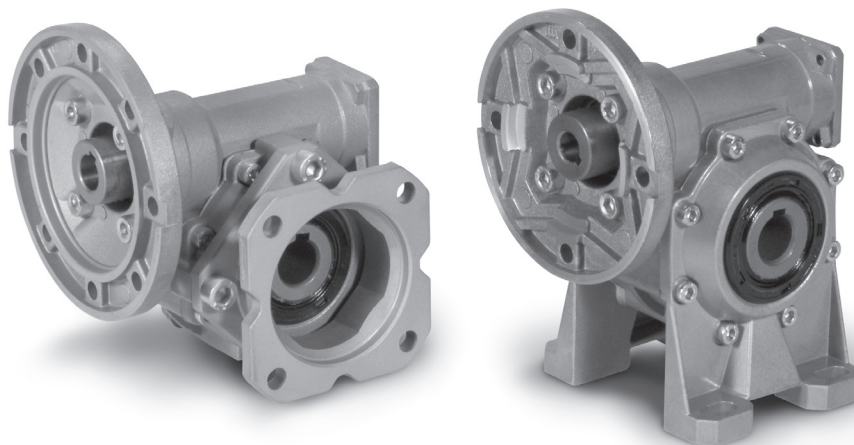

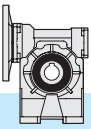

3.1 Caratteristiche

- I riduttori della serie a vite senza fine KC si presentano estremamente leggeri grazie alla forma compatta della carcassa in ghisa nelle grandezze 90, 110 e 130, in alluminio pressofuso per le grandezze 30, 40, 50, 63 e 75.
- La serie presenta una svariata possibilità di versioni, con e senza piedi, che la rendono più versatile nell'impiego in ogni tipologia di applicazione.
- La serie K è disponibile esclusivamente nella versione predisposta per attacco motore (PAM) e non con albero entrata maschio.
- La vite senza fine è in acciaio legato cementato-temprato ed è rettificata.
- La corona ha il mozzo in ghisa con riporto di fusione dell'anello in bronzo.
- Le carcasse in ghisa sono verniciate BLU RAL5010 mentre quelle in alluminio sono sabbiate.
- Viene fornito l'albero uscita cavo di serie ed esiste un'ampia disponibilità di accessori: seconda entrata, cuscinetti conici sulla corona, flangia uscita, albero lento con 1 o 2 sporgenze, limitatore di coppia con cavo passante, braccio di reazione, kit protezione albero cavo, kit protezione limitatore di coppia.

3.1 Characteristics

- *The KC worm gearboxes are extremely light thanks to the compact shape of the housing, which is in cast iron for sizes 90, 110 and 130, in die-cast aluminium for sizes 30, 40, 50, 63 and 75.*
- *This series features a wide range of versions, with and without feet, which makes it extremely versatile for utilization in various applications.*
- *The K series is available for motor mounting version (PAM) only and not with the male input shaft.*
- *The worm shaft is in case-and quench-hardened alloy steel and ground.*
- *The worm wheel has a cast-iron hub with inserted cast bronze ring.*
- *The cast-iron housings are painted BLUE RAL5010 whereas the aluminium housings are sandblasted.*
- *The hollow output shaft is supplied as standard. A broad range of accessories is available: second input, tapered roller bearings on the worm wheel, output flange, single or double-extended output shaft, torque limiter with through hollow shaft, torque arm, hollow shaft protection kit, torque limiter protection kit.*

3.1 Merkmale

- Die Schneckengetriebe der Serie KC sind äußerst leicht dank der kompakten Form des Gehäuses. Das Gehäuse ist aus Gusseisen für Größen 90, 110 und 130, aus Druckgussaluminium für Größen 30, 40, 50, 63 und 75.
- Diese Serie ist in vielen Ausführungen, mit und ohne Füße erhältlich, was eine vielseitige Anwendbarkeit in unterschiedlichsten Applikationen ermöglicht.
- Die Serie K ist nur mit Motoranbau Version (IEC) und nicht mit einer Antriebswelle verfügbar.
- Die Schneckenwelle ist aus einsatzgehärtetem / abgeschrecktem und daraufhin geschliffenem Legierungsstahl.
- Das Schneckenrad besteht aus einer Nabe aus Gusseisen und einem aufgeschleuderten Gussbronze-Ring.
- Gehäuse aus Gusseisen werden mit BLAU RAL5010 lackiert, die Gehäuse aus Aluminium werden sandgestrahlt.
- Die Hohlwelle gehört zur serienmäßigen Ausstattung. Eine breite Auswahl an Zubehör ist erhältlich: zweiter Antrieb, Kegellager auf das Schneckenrad, Abtriebsflansch, Standard oder doppelseitig herausragende Abtriebswelle, Drehmomentbegrenzer mit durchgehender Hohlwelle, Drehmomentstütze, Schutzvorrichtung für Hohlwelle, Schutzvorrichtung für Drehmomentbegrenzer.

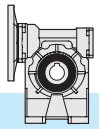

3.2 Designazione

3.2 Designation

3.2 Bezeichnung

Riduttore Gearbox Getriebe	Tipo entrata Input type Antriebsart	Grandezza Size Größe	Versione Version Ausführung	Rapporto rid. Ratio Untersetzung	Predispos. att. mot. Motor coupling Motoranschluss	Posizione di mont. Mounting position Einbaulage	Limitatore di coppia. Torque limiter Drehmomentbegrenzer	Seconda entrata Additional input Zusatzantrieb	Albero uscita Output shaft Abtriebswelle	Braccio di reazione Torque arm Drehmomentstütze
K	C	50	F1S	10	P.A.M	B3	LD	SeA	H	BR
Riduttore a vite senza fine Wormgearbox Schneckengetriebe		30 40 50 63 75 90 110 130	A1-A2 B1-B2 V1-V2 P F1S-F2S F3S F1D-F2D F3D	5 7.5 10 15 20 25 30 40 50 65 80 100	56 63 71 80 90 100 112 132	B3 B6 B7 B8 V5 V6	 LS LD	 SeA	 H SD SS DD	 BR

Versioni

Versions

Ausführungen

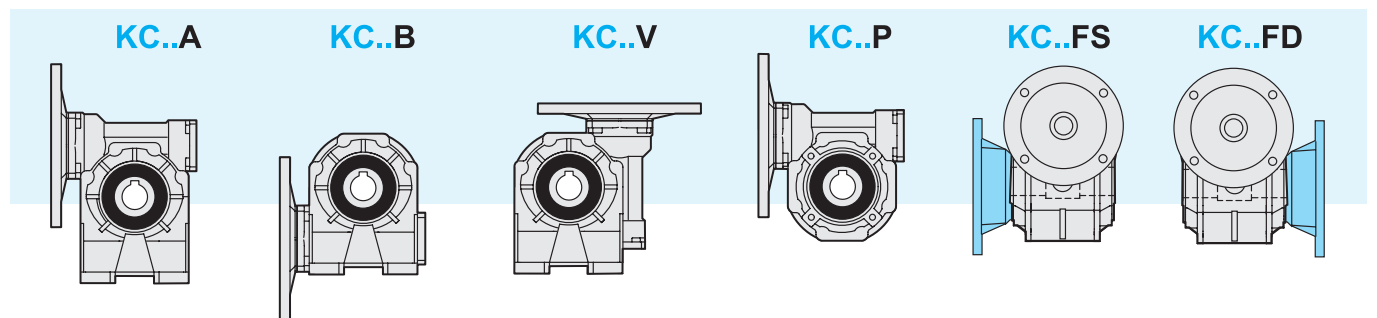

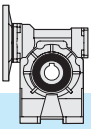

3.3 Lubrificazione

I riduttori a vite senza fine serie K, tranne la grandezza 130, sono forniti completi di lubrificante sintetico a base PAG con indice di viscosità ISO VG320. Si raccomanda di precisare sempre, in fase di ordine, la posizione di montaggio desiderata.

3.3 Lubrication

KC worm gearboxes, except for the size 130, are supplied with PAG synthetic lubricant featuring an ISO VG320 viscosity class. Mounting position always to be specified when ordering.

3.3 Schmierung

Schneckengetriebe der Serie KC, außer Größe 130, werden mit synthetischem Schmiermittel auf PAG Basis und Viskosität Index ISO VG320 geliefert. Im Auftrag bitte immer die gewünschte Einbaulage angeben.

Posizioni di montaggio

Mounting positions

Einbaulagen

F,P

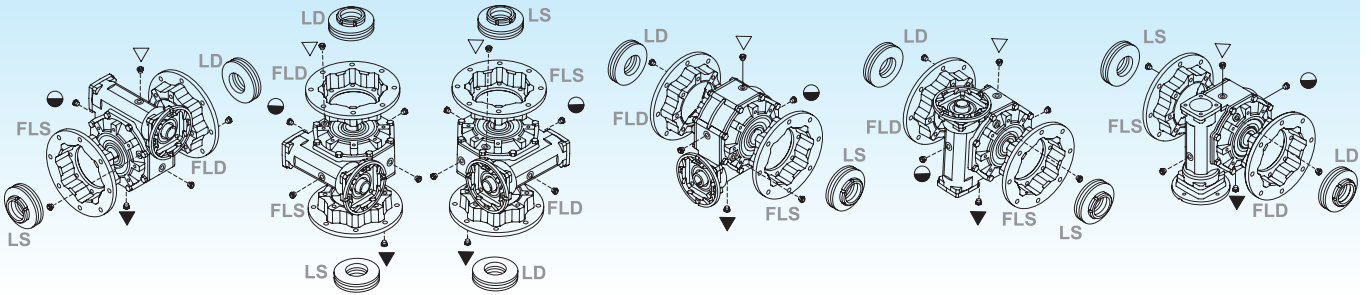

A

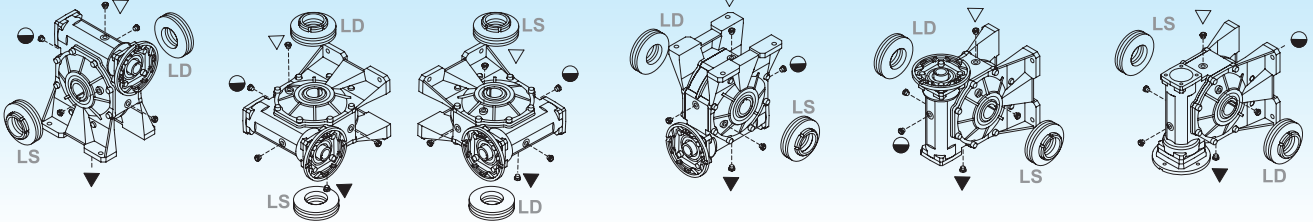

V

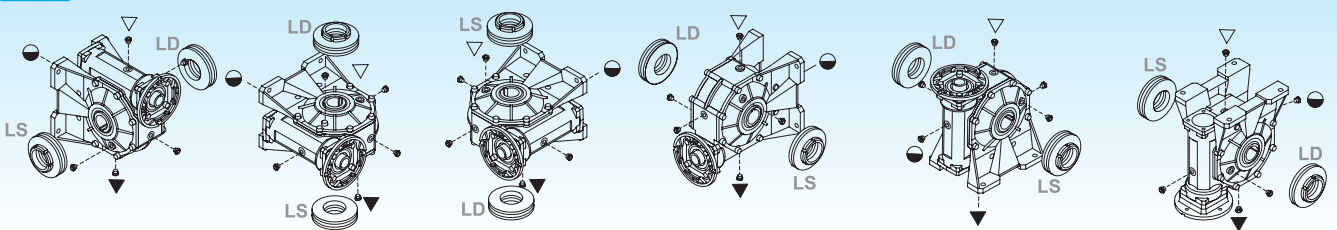

B

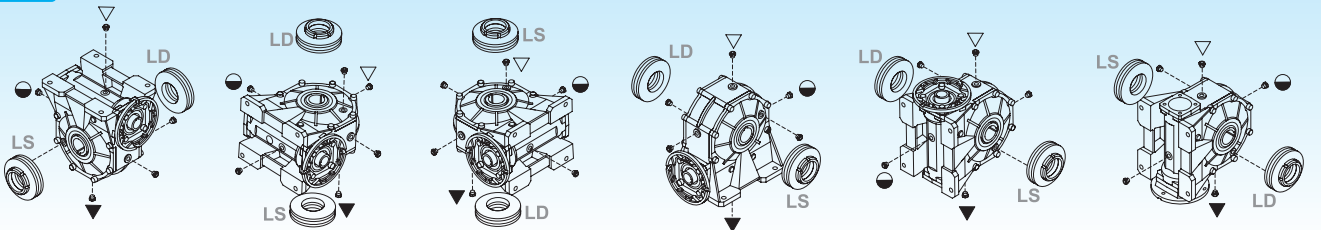

B3

B6

B7

B8

V5

V6

- ▽ Carico e sfiato / Filling and breather
Einfüll und Entlüftung
- Livello / Level / Ölstand
- ▼ Scarico / Drain / Ablass

Nei corpi in alluminio 30, 40, 50, 63, 75 è presente un solo tappo di riempimento olio.

Aluminium housings size 30, 40, 50, 63 and 75 have one filling plug only.

Gehäuse aus Aluminium Größe 30, 40, 50, 63 und 75 verfügen über nur eine Einfüllschraube.

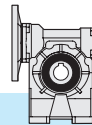

3.3 Lubrificazione

3.3 Lubrication

3.3 Schmierung

		Q.tà olio / Oil quantity / Schmiermittelmenge [lt]			
		Posizione di montaggio / Mounting position / Einbaulage			
		B3	B6 - B7	B8	V5 - V6
KC	30	0.015	0.030	0.015	
	40	0.040	0.060	0.040	
	50	0.080	0.120	0.080	
	63	0.160	0.220	0.160	
	75	0.260	0.340	0.260	
	90	1	0.8	0.8	1.3
	110	2	1.5	2	2
	130	3	2.6	2.1	2.8

3.4 Posizione morsettiera

3.4 Terminal board position

3.4 Lage der Klemmenkaste

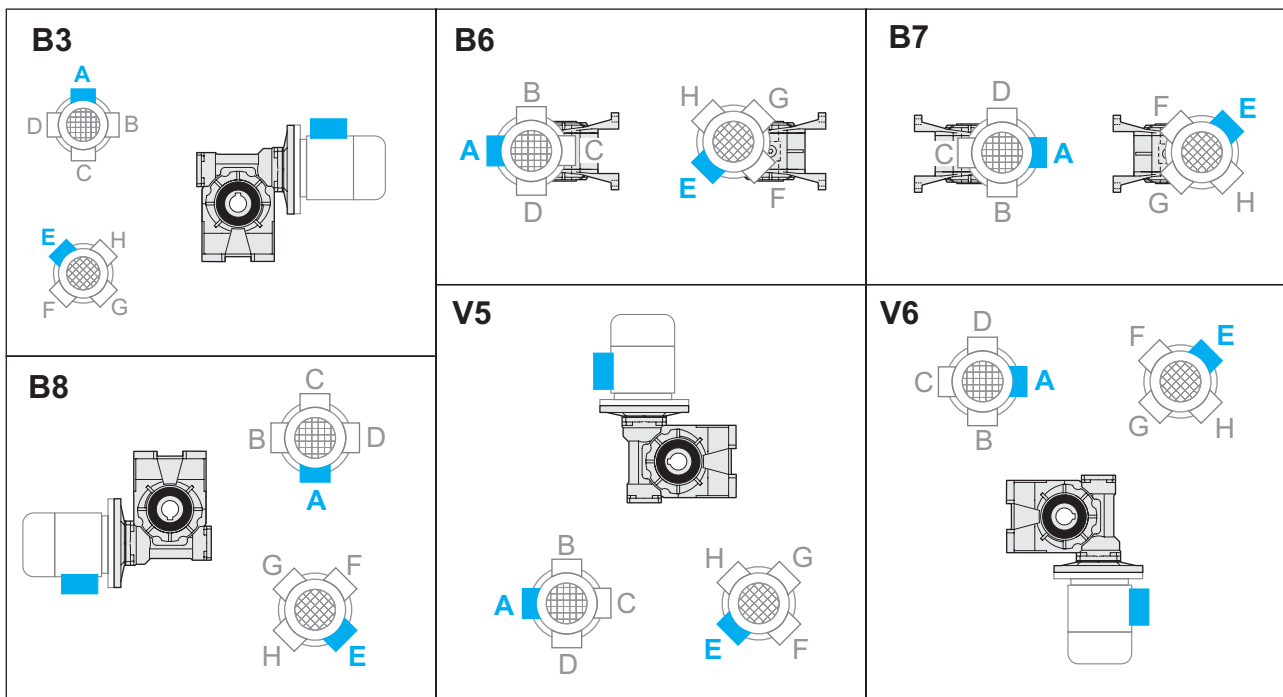

Specificare sempre in fase di ordinazione la posizione di montaggio e la forma costruttiva.
 Posizione morsettiera v. pag. 58
 (PM=1; PM=2)

Mounting position always to be specified when ordering.
Terminal board position see page 58
 (PM=1; PM=2)

Bei der Bestellung immer die gewünschte Montageposition und Bauform angeben.
 Lage der Klemmenkaste Seite 58
 (PM=1; PM=2)

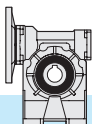

30	$n_1 = 2800$				KC				Input - IEC	
	i_n	n_2 [min ⁻¹]	Rd	P_{10}	T_2 [Nm]	P_1 [kW]	FS'	B5/B14		
	5	560	0.89	—	5.6	0.37	2.5	63	56	
7.5	373	0.86	8		0.37	2.0				
10	280	0.84	11		0.37	1.5				
15	187	0.81	15		0.37	1.1				
20	140	0.76	13		0.25	1.2				
25	112	0.74	16		0.25	1.0				
30	93	0.71	13		0.18	1.0				
40	70	0.65	16		0.18	1.0				
50	56	0.62	14		0.13	1.1				
65	43	0.57	17		0.13	1.0				
80	35	0.54	13		0.09	1.0				
100	28	0.52	16		0.09	0.8	—			



30	$n_1 = 1400$				KC				Input - IEC	
	i_n	n_2 [min ⁻¹]	Rd	P_{10}	T_2 [Nm]	P_1 [kW]	FS'	B5/B14		
	5	280	0.87	0.40	6.5	0.22	2.9	63	56	
7.5	187	0.84	0.40	9	0.22	2.2				
10	140	0.82	0.40	12	0.22	1.8				
15	93	0.77	0.30	17	0.22	1.3				
20	70	0.72	0.20	18	0.18	1.1				
25	56	0.69	0.20	21	0.18	1.0				
30	47	0.66	0.20	18	0.13	1.1				
40	35	0.59	0.20	21	0.13	1.0				
50	28	0.55	0.20	17	0.09	1.1				
65	22	0.51	0.10	20	0.09	1.0				
80	18	0.48	0.10	16	0.06	1.0				
100	14	0.45	0.10	18	0.06	0.8	—			



30	$n_1 = 900$				KC				Input - IEC	
	i_n	n_2 [min ⁻¹]	Rd	P_{10}	T_2 [Nm]	P_1 [kW]	FS'	B5/B14		
	5	180	0.85	—	5.9	0.13	3.9	63	56	
7.5	120	0.82	9		0.13	2.9				
10	90	0.80	11		0.13	2.3				
15	60	0.75	15		0.13	1.6				
20	45	0.69	19		0.13	1.2				
25	36	0.66	23		0.13	1.1				
30	30	0.63	18		0.09	1.2				
40	23	0.55	21		0.09	1.1				
50	18	0.52	16		0.06	1.3				
65	14	0.48	20		0.06	1.1				
80	11	0.44	11		0.03	1.7				
100	9	0.42	13		0.03	1.1	—			



30	$n_1 = 500$				KC				Input - IEC	
	i_n	n_2 [min ⁻¹]	Rd	P_{10}	T_2 [Nm]	P_1 [kW]	FS'	B5/B14		
	5	100	0.83	—	—	—	—	63	56	
7.5	67	0.80	—		—	—				
10	50	0.77	—		—	—				
15	33	0.72	—		—	—				
20	25	0.66	—		—	—				
25	20	0.62	—		—	—				
30	17	0.59	—		—	—				
40	13	0.51	—		—	—				
50	10	0.48	—		—	—				
65	8	0.43	—		—	—				
80	6	0.40	—		—	—				
100	5	0.38	—		—	—	—			



* **ATTENZIONE:** la coppia massima utilizzabile $[T_{2M}]$ deve essere calcolata utilizzando il fattore di servizio: $T_{2M} = T_2 \times FS'$

* **WARNING:** Maximum allowable torque $[T_{2M}]$ must be calculated using the following service factor: $T_{2M} = T_2 \times FS'$

* **ACHTUNG:** das max. anwendbare Drehmoment $[T_{2M}]$ muss mit folgendem Betriebsfaktor berechnet werden: $T_{2M} = T_2 \times FS'$

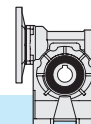

3.5 Dati tecnici

3.5 Technical data

3.5 Technische Daten

40	$n_1 = 2800$				KC					
	i_n	n_2 [min ⁻¹]	Rd	P_{t0}	T_2 [Nm]	P_1 [kW]	FS'	Input - IEC B5/B14		
		5	560	0.88	—	11.3	0.75	2.2	71	63
	7.5	373	0.87	17		0.75	1.8			
	10	280	0.86	22		0.75	1.4			
	15	187	0.82	32		0.75	1.0			
	20	140	0.80	30		0.55	1.0			
	25	112	0.76	24		0.37	1.1			
	30	93	0.73	28		0.37	1.3			
	40	70	0.70	24		0.25	1.4			
	50	56	0.65	28		0.25	1.1			
	65	43	0.61	24		0.18	1.2			
	80	35	0.58	21		0.13	1.3			
	100	28	0.55	24	0.13	1.0	—	56		

40	$n_1 = 1400$				KC					
	i_n	n_2 [min ⁻¹]	Rd	P_{t0}	T_2 [Nm]	P_1 [kW]	FS'	Input - IEC B5/B14		
		5	280	0.87	0.80	16.3	0.55	2.1	71	63
	7.5	187	0.85	0.80	24	0.55	1.7			
	10	140	0.83	0.70	31	0.55	1.3			
	15	93	0.79	0.50	30	0.37	1.4			
	20	70	0.76	0.50	38	0.37	1.0			
	25	56	0.72	0.40	31	0.25	1.1			
	30	47	0.68	0.40	35	0.25	1.2			
	40	35	0.64	0.30	38	0.22	1.0			
	50	28	0.59	0.30	36	0.18	1.1			
	65	22	0.54	0.20	31	0.13	1.1			
	80	18	0.52	0.20	31	0.11	1.1	—		
	100	14	0.49	0.20	30	0.09	0.9			

40	$n_1 = 900$				KC					
	i_n	n_2 [min ⁻¹]	Rd	P_{t0}	T_2 [Nm]	P_1 [kW]	FS'	Input - IEC B5/B14		
		5	180	0.85	—	16.7	0.37	2.5	71	63
	7.5	120	0.83	25		0.37	2.0			
	10	90	0.81	32		0.37	1.5			
	15	60	0.76	45		0.37	1.1			
	20	45	0.74	39		0.25	1.2			
	25	36	0.69	33		0.18	1.3			
	30	30	0.65	37		0.18	1.3			
	40	23	0.61	33		0.13	1.3			
	50	18	0.55	38		0.13	1.1			
	65	14	0.51	32		0.09	1.2			
	80	11	0.48	37		0.09	1.0	—		
	100	9	0.45	29	0.06	1.0				

40	$n_1 = 500$				KC					
	i_n	n_2 [min ⁻¹]	Rd	P_{t0}	T_2 [Nm]	P_1 [kW]	FS'	Input - IEC B5/B14		
		5	100	0.83	—	7.1	0.09	7.1	71	63
	7.5	67	0.81	10		0.09	5.5			
	10	50	0.79	14		0.09	4.4			
	15	33	0.73	19		0.09	3.1			
	20	25	0.70	24		0.09	2.3			
	25	20	0.65	28		0.09	1.7			
	30	17	0.61	31		0.09	1.8			
	40	13	0.57	39		0.09	1.3			
	50	10	0.51	44		0.09	1.2			
	65	8	0.46	52		0.09	0.9			
	80	6	0.44	61*		0.09	0.7*	—		
	100	5	0.41	71*	0.09	0.4*				

* **ATTENZIONE:** la coppia massima utilizzabile [T_{2M}] deve essere calcolata utilizzando il fattore di servizio: $T_{2M} = T_2 \times FS'$

* **WARNING:** Maximum allowable torque [T_{2M}] must be calculated using the following service factor: $T_{2M} = T_2 \times FS'$

* **ACHTUNG:** das max. anwendbare Drehmoment [T_{2M}] muss mit folgendem Betriebsfaktor berechnet werden: $T_{2M} = T_2 \times FS'$

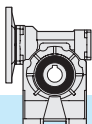

50	$n_1 = 2800$				KC				Input - IEC B5/B14		
	i_n	n_2 [min ⁻¹]	Rd	P_{t0}	T_2 [Nm]	P_1 [kW]	FS'	80	71	63	
Kg 3.4	5	560	0.89	—	22.8	1.5	1.9				—
	7.5	373	0.88		34	1.5	1.5				
	10	280	0.86		44	1.5	1.2				
	15	187	0.84		47	1.1	1.2				
	20	140	0.81		42	0.75	1.4				
	25	112	0.78		50	0.75	1.0				
	30	93	0.75		42	0.55	1.3				
	40	70	0.72		54	0.55	1.0				
	50	56	0.68		43	0.37	1.3				
	65	43	0.64		53	0.37	1.0				
80	35	0.61	41	0.25	1.2						
100	28	0.58	35	0.18	1.3						

50	$n_1 = 1400$				KC				Input - IEC B5/B14		
	i_n	n_2 [min ⁻¹]	Rd	P_{t0}	T_2 [Nm]	P_1 [kW]	FS'	80	71	63	
Kg 3.4	5	280	0.87	1.2	26.7	0.9	2.3				80
	7.5	187	0.86	1.2	40	0.9	1.8				
	10	140	0.84	1.0	52	0.9	1.4				
	15	93	0.80	0.80	74	0.9	1.0				
	20	70	0.78	0.70	58	0.55	1.3				
	25	56	0.74	0.60	47	0.37	1.4				
	30	47	0.71	0.60	53	0.37	1.2				
	40	35	0.67	0.50	68	0.37	1.0				
	50	28	0.62	0.40	53	0.25	1.3				
	65	22	0.58	0.40	64	0.25	1.0				
80	18	0.54	0.40	53	0.18	1.1					
100	14	0.51	0.30	45	0.13	1.2					

50	$n_1 = 900$				KC				Input - IEC B5/B14		
	i_n	n_2 [min ⁻¹]	Rd	P_{t0}	T_2 [Nm]	P_1 [kW]	FS'	80	71	63	
Kg 3.4	5	180	0.85	—	33.8	0.75	2.2				80
	7.5	120	0.84		50	0.75	1.6				
	10	90	0.82		66	0.75	1.3				
	15	60	0.78		68	0.55	1.3				
	20	45	0.75		59	0.37	1.5				
	25	36	0.71		70	0.37	1.1				
	30	30	0.67		79	0.37	1.0				
	40	23	0.63		67	0.25	1.1				
	50	18	0.59		78	0.25	1.0				
	65	14	0.54		67	0.18	1.1				
80	11	0.51	56	0.13	1.2						
100	9	0.47	45	0.09	1.3						

50	$n_1 = 500$				KC				Input - IEC B5/B14		
	i_n	n_2 [min ⁻¹]	Rd	P_{t0}	T_2 [Nm]	P_1 [kW]	FS'	80	71	63	
Kg 3.4	5	100	0.84	—	14.3	0.18	6.4				80
	7.5	67	0.82		21	0.18	4.7				
	10	50	0.80		28	0.18	3.8				
	15	33	0.75		39	0.18	2.7				
	20	25	0.72		50	0.18	2.1				
	25	20	0.68		58	0.18	1.5				
	30	17	0.63		65	0.18	1.5				
	40	13	0.59		81	0.18	1.2				
	50	10	0.54		93	0.18	1.0				
	65	8	0.50		56	0.09	1.5				
80	6	0.46	63	0.09	1.2						
100	5	0.43	74	0.09	0.8						

* **ATTENZIONE:** la coppia massima utilizzabile $[T_{2M}]$ deve essere calcolata utilizzando il fattore di servizio: $T_{2M} = T_2 \times FS'$

* **WARNING:** Maximum allowable torque $[T_{2M}]$ must be calculated using the following service factor: $T_{2M} = T_2 \times FS'$

* **ACHTUNG:** das max. anwendbare Drehmoment $[T_{2M}]$ muss mit folgendem Betriebsfaktor berechnet werden: $T_{2M} = T_2 \times FS'$

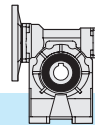

3.5 Dati tecnici

3.5 Technical data

3.5 Technische Daten

63	$n_1 = 2800$				KC				Input - IEC B5/B14		
	i_n	n_2 [min ⁻¹]	Rd	P_{t0}	T_2 [Nm]	P_1 [kW]	FS'	90	80	—	
	5	560	0.89	—	45.5	3	1.7				—
7.5	373	0.88	68		3	1.3					
10	280	0.87	89		3	1.1					
15	187	0.84	95		2.2	1.0					
20	140	0.83	85		1.5	1.3					
25	112	0.81	76		1.1	1.2					
30	93	0.77	87		1.1	1.3					
40	70	0.74	111		1.1	1.1					
50	56	0.70	90		0.75	1.1					
65	43	0.67	81		0.55	1.2					
80	35	0.64	65		0.37	1.4					
100	28	0.60	75	0.37	1.1						

5.7

63	$n_1 = 1400$				KC				Input - IEC B5/B14		
	i_n	n_2 [min ⁻¹]	Rd	P_{t0}	T_2 [Nm]	P_1 [kW]	FS'	90	80	—	
	5	280	0.88	1.8	54	1.8	2.0				—
7.5	187	0.87	1.8	80	1.8	1.5					
10	140	0.85	1.6	105	1.8	1.2					
15	93	0.81	1.2	125	1.5	1.1					
20	70	0.80	1.2	120	1.1	1.2					
25	56	0.77	1.0	118	0.9	1.0					
30	47	0.73	0.90	134	0.9	1.1					
40	35	0.69	0.80	142	0.75	1.1					
50	28	0.65	0.70	122	0.55	1.0					
65	22	0.61	0.60	100	0.37	1.2					
80	18	0.58	0.60	79	0.25	1.4					
100	14	0.53	0.50	91	0.25	1.1					

5.7

63	$n_1 = 900$				KC				Input - IEC B5/B14		
	i_n	n_2 [min ⁻¹]	Rd	P_{t0}	T_2 [Nm]	P_1 [kW]	FS'	90	80	—	
	5	180	0.87	—	69	1.5	1.9				—
7.5	120	0.85	102		1.5	1.4					
10	90	0.83	133		1.5	1.1					
15	60	0.79	139		1.1	1.1					
20	45	0.77	123		0.75	1.4					
25	36	0.74	109		0.55	1.3					
30	30	0.70	122		0.55	1.3					
40	23	0.66	154		0.55	1.1					
50	18	0.61	120		0.37	1.2					
65	14	0.57	98		0.25	1.4					
80	11	0.54	115		0.25	1.1					
100	9	0.50	95	0.18	1.2						

5.7

63	$n_1 = 500$				KC				Input - IEC B5/B14		
	i_n	n_2 [min ⁻¹]	Rd	P_{t0}	T_2 [Nm]	P_1 [kW]	FS'	90	80	—	
	5	100	0.85	—	20	0.25	8.3				—
7.5	67	0.83	30		0.25	5.9					
10	50	0.81	39		0.25	4.7					
15	33	0.76	55		0.25	3.4					
20	25	0.74	71		0.25	2.8					
25	20	0.71	85		0.25	1.9					
30	17	0.65	94		0.25	2.1					
40	13	0.62	118		0.25	1.7					
50	10	0.56	135		0.25	1.2					
65	8	0.52	163		0.25	1.0					
80	6	0.50	137		0.18	1.1					
100	5	0.45	77	0.09	1.6						

5.7

* **ATTENZIONE:** la coppia massima utilizzabile $[T_{2M}]$ deve essere calcolata utilizzando il fattore di servizio: $T_{2M} = T_2 \times FS'$

* **WARNING:** Maximum allowable torque $[T_{2M}]$ must be calculated using the following service factor: $T_{2M} = T_2 \times FS'$

* **ACHTUNG:** das max. anwendbare Drehmoment $[T_{2M}]$ muss mit folgendem Betriebsfaktor berechnet werden: $T_{2M} = T_2 \times FS'$

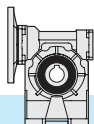

3.5 Dati tecnici

3.5 Technical data

3.5 Technische Daten

75	$n_1 = 2800$				KC					
	i_n	n_2 [min ⁻¹]	Rd	P_{t0}	T_2 [Nm]	P_1 [kW]	FS'	Input - IEC B5/B14		
									112 100	90
Kg 9.5	7.5	373	0.89	—	125	5.5	1.0	—	90	80
	10	280	0.88		120	4	1.2			
	15	187	0.85		131	3	1.2			
	20	140	0.84		171	3	1.0			
	25	112	0.82		154	2.2	1.0			
	30	93	0.78		120	1.5	1.4			
	40	70	0.75		154	1.5	1.2			
	50	56	0.73		136	1.1	1.2			
	65	43	0.69		114	0.75	1.4			
	80	35	0.66		135	0.75	1.1			
100	28	0.62	159	0.75	0.8					

75	$n_1 = 1400$				KC					
	i_n	n_2 [min ⁻¹]	Rd	P_{t0}	T_2 [Nm]	P_1 [kW]	FS'	Input - IEC B5/B14		
									112 100	90
Kg 9.5	7.5	187	0.87	2.5	178	4	1.0	—	90	80
	10	140	0.86	2.3	176	3	1.1			
	15	93	0.83	1.9	187	2.2	1.1			
	20	70	0.81	1.7	199	1.8	1.1			
	25	56	0.78	1.5	200	1.5	1.0			
	30	47	0.74	1.2	167	1.1	1.3			
	40	35	0.71	1.1	213	1.1	1.1			
	50	28	0.67	1.0	206	0.9	1.0			
	65	22	0.63	0.90	154	0.55	1.3			
	80	18	0.60	0.80	180	0.55	1.0			
100	14	0.56	0.70	210	0.55	0.8				

75	$n_1 = 900$				KC					
	i_n	n_2 [min ⁻¹]	Rd	P_{t0}	T_2 [Nm]	P_1 [kW]	FS'	Input - IEC B5/B14		
									112 100	90
Kg 9.5	7.5	120	0.86	—	205	3	1.0	—	90	80
	10	90	0.84		197	2.2	1.2			
	15	60	0.81		231	1.8	1.0			
	20	45	0.78		250	1.5	1.1			
	25	36	0.76		221	1.1	1.1			
	30	30	0.71		249	1.1	1.0			
	40	23	0.67		214	0.75	1.3			
	50	18	0.64		186	0.55	1.3			
	65	14	0.59		151	0.37	1.5			
	80	11	0.56		177	0.37	1.2			
100	9	0.52	203	0.37	0.9					

75	$n_1 = 500$				KC					
	i_n	n_2 [min ⁻¹]	Rd	P_{t0}	T_2 [Nm]	P_1 [kW]	FS'	Input - IEC B5/B14		
									112 100	90
Kg 9.5	7.5	67	0.84	—	90	0.75	2.9	—	90	80
	10	50	0.82		118	0.75	2.4			
	15	33	0.78		167	0.75	1.7			
	20	25	0.75		216	0.75	1.5			
	25	20	0.72		260	0.75	1.1			
	30	17	0.67		288	0.75	1.1			
	40	13	0.63		265	0.55	1.2			
	50	10	0.59		210	0.37	1.3			
	65	8	0.55		251	0.37	1.0			
	80	6	0.52		197	0.25	1.2			
100	5	0.47	161	0.18	1.3					

* **ATTENZIONE:** la coppia massima utilizzabile $[T_{2M}]$ deve essere calcolata utilizzando il fattore di servizio: $T_{2M} = T_2 \times FS'$

* **WARNING:** Maximum allowable torque $[T_{2M}]$ must be calculated using the following service factor: $T_{2M} = T_2 \times FS'$

* **ACHTUNG:** das max. anwendbare Drehmoment $[T_{2M}]$ muss mit folgendem Betriebsfaktor berechnet werden: $T_{2M} = T_2 \times FS'$

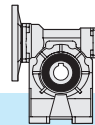

3.5 Dati tecnici

3.5 Technical data

3.5 Technische Daten

90	$n_1 = 2800$				KC					
	i_n	n_2 [min ⁻¹]	Rd	P_{t0}	T_2 [Nm]	P_1 [kW]	FS'	Input - IEC B5/B14		
	7.5	373	0.89	—	171	7.5	1.2	112 100	90	—
10	280	0.88	165		5.5	1.3				
15	187	0.86	241		5.5	1.0				
20	140	0.84	230		4	1.2				
25	112	0.83	212		3	1.2				
30	93	0.79	243		3	1.1				
40	70	0.77	230		2.2	1.3	—	80		
50	56	0.74	278		2.2	1.0				
65	43	0.71	235		1.5	1.1				
80	35	0.68	205		1.1	1.2				
100	28	0.64	163		0.75	1.3				

 16.4

90	$n_1 = 1400$				KC					
	i_n	n_2 [min ⁻¹]	Rd	P_{t0}	T_2 [Nm]	P_1 [kW]	FS'	Input - IEC B5/B14		
	7.5	187	0.88	3.0	247	5.5	1.2	112 100	90	—
10	140	0.86	2.5	236	4	1.3				
15	93	0.84	2.2	256	3	1.2				
20	70	0.82	2.0	334	3	1.1				
25	56	0.80	1.8	299	2.2	1.1				
30	47	0.76	1.5	340	2.2	1.0				
40	35	0.72	1.3	355	1.8	1.1	—	80		
50	28	0.69	1.1	353	1.5	1.0				
65	22	0.65	1.0	317	1.1	1.0				
80	18	0.63	1.0	309	0.9	1.0				
100	14	0.58	0.80	217	0.55	1.2				

 16.4

90	$n_1 = 900$				KC					
	i_n	n_2 [min ⁻¹]	Rd	P_{t0}	T_2 [Nm]	P_1 [kW]	FS'	Input - IEC B5/B14		
	7.5	120	0.86	—	206	3	1.7	112 100	90	—
10	90	0.85	270		3	1.3				
15	60	0.82	286		2.2	1.3				
20	45	0.79	371		2.2	1.1				
25	36	0.77	369		1.8	1.0				
30	30	0.73	416		1.8	1.0				
40	23	0.69	440		1.5	1.0	—	80		
50	18	0.66	384		1.1	1.0				
65	14	0.62	319		0.75	1.1				
80	11	0.59	274		0.55	1.2				
100	9	0.54	313		0.55	1.0				

 16.4

90	$n_1 = 500$				KC					
	i_n	n_2 [min ⁻¹]	Rd	P_{t0}	T_2 [Nm]	P_1 [kW]	FS'	Input - IEC B5/B14		
	7.5	67	0.84	—	91	0.75	4.7	112 100	90	—
10	50	0.83	118		0.75	3.7				
15	33	0.79	169		0.75	2.7				
20	25	0.76	219		0.75	2.3				
25	20	0.74	265		0.75	1.7				
30	17	0.68	294		0.75	1.6				
40	13	0.65	371		0.75	1.4	—	80		
50	10	0.61	439		0.75	1.1				
65	8	0.57	388		0.55	1.1				
80	6	0.54	305		0.37	1.3				
100	5	0.49	344		0.37	1.0				

 16.4

* **ATTENZIONE:** la coppia massima utilizzabile $[T_{2M}]$ deve essere calcolata utilizzando il fattore di servizio: $T_{2M} = T_2 \times FS'$

* **WARNING:** Maximum allowable torque $[T_{2M}]$ must be calculated using the following service factor: $T_{2M} = T_2 \times FS'$

* **ACHTUNG:** das max. anwendbare Drehmoment $[T_{2M}]$ muss mit folgendem Betriebsfaktor berechnet werden: $T_{2M} = T_2 \times FS'$

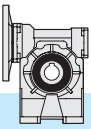

3.5 Dati tecnici

3.5 Technical data

3.5 Technische Daten

110	$n_1 = 2800$				KC					
	i_n	n_2 [min ⁻¹]	Rd	P_{t0}	T_2 [Nm]	P_1 [kW]	FS'	Input - IEC B5/B14		
 31.5	7.5	373	0.89	—	343	15	1.0	132	112 100	—
	10	280	0.88		332	11	1.1			
	15	187	0.86		331	7.5	1.2			
	20	140	0.85		435	7.5	1.1			
	25	112	0.84		393	5.5	1.1			
	30	93	0.80		450	5.5	1.0			
	40	70	0.78		424	4	1.2	—		90
	50	56	0.76		388	3	1.2			—
	65	43	0.73		354	2.2	1.2			—
	80	35	0.70		287	1.5	1.4			—
100	28	0.66	339	1.5	1.1	—				

110	$n_1 = 1400$				KC					
	i_n	n_2 [min ⁻¹]	Rd	P_{t0}	T_2 [Nm]	P_1 [kW]	FS'	Input - IEC B5/B14		
 31.5	7.5	187	0.88	4.3	415	9.2	1.2	132	112 100	—
	10	140	0.87	4.0	446	7.5	1.1			
	15	93	0.84	3.2	475	5.5	1.1			
	20	70	0.83	3.0	623	5.5	1.0			
	25	56	0.81	2.7	554	4	1.0			
	30	47	0.77	2.2	472	3	1.3			
	40	35	0.74	2.0	606	3	1.1	—		90
	50	28	0.72	1.8	538	2.2	1.1			—
	65	22	0.68	1.6	451	1.5	1.2			—
	80	18	0.65	1.5	390	1.1	1.3			—
100	14	0.61	1.3	458	1.1	1.0	—			

110	$n_1 = 900$				KC					
	i_n	n_2 [min ⁻¹]	Rd	P_{t0}	T_2 [Nm]	P_1 [kW]	FS'	Input - IEC B5/B14		
 31.5	7.5	120	0.87	—	381	5.5	1.5	132	112 100	—
	10	90	0.86		500	5.5	1.2			
	15	60	0.83		526	4	1.2			
	20	45	0.81		685	4	1.1			
	25	36	0.79		628	3	1.1			
	30	30	0.74		520	2.2	1.3			
	40	23	0.71		664	2.2	1.1	—		90
	50	18	0.68		653	1.8	1.1			—
	65	14	0.64		487	1.1	1.2			—
	80	11	0.61		570	1.1	1.0			—
100	9	0.57	450	0.75	1.1	—				

110	$n_1 = 500$				KC					
	i_n	n_2 [min ⁻¹]	Rd	P_{t0}	T_2 [Nm]	P_1 [kW]	FS'	Input - IEC B5/B14		
 31.5	7.5	67	0.85	—	183	1.5	3.9	132	112 100	—
	10	50	0.84		240	1.5	3.1			
	15	33	0.80		344	1.5	2.3			
	20	25	0.78		446	1.5	1.9			
	25	20	0.76		542	1.5	1.5			
	30	17	0.70		603	1.5	1.4			
	40	13	0.67		765	1.5	1.2	—		90
	50	10	0.64		671	1.1	1.2			—
	65	8	0.59		553	0.75	1.3			—
	80	6	0.56		643	0.75	1.0			—
100	5	0.52	542	0.55	1.1	—				

* **ATTENZIONE:** la coppia massima utilizzabile $[T_{2M}]$ deve essere calcolata utilizzando il fattore di servizio: $T_{2M} = T_2 \times FS'$

* **WARNING:** Maximum allowable torque $[T_{2M}]$ must be calculated using the following service factor: $T_{2M} = T_2 \times FS'$

* **ACHTUNG:** das max. anwendbare Drehmoment $[T_{2M}]$ muss mit folgendem Betriebsfaktor berechnet werden: $T_{2M} = T_2 \times FS'$

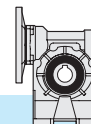

3.5 Dati tecnici

3.5 Technical data

3.5 Technische Daten

130	$n_1 = 2800$				KC				Input - IEC B5/B14		
	i_n	n_2 [min ⁻¹]	Rd	P_{t0}	T_2 [Nm]	P_1 [kW]	FS'	132	112 100	—	
Kg 45	7.5	373	0.90	—	345	15	1.5	—	112 100	—	
	10	280	0.89		455	15	1.2				
	15	187	0.87		490	11	1.3				
	20	140	0.86		645	11	1.1				
	25	112	0.85		667	9.2	1.1				
	30	93	0.81		622	7.5	1.2				
	40	70	0.80		819	7.5	1.0				
	50	56	0.78		732	5.5	1.0				
	65	43	0.75		499	3	1.3				
	80	35	0.73		598	3	1.1				
	100	28	0.70		525	2.2	1.1				

130	$n_1 = 1400$				KC				Input - IEC B5/B14		
	i_n	n_2 [min ⁻¹]	Rd	P_{t0}	T_2 [Nm]	P_1 [kW]	FS'	132	112 100	—	
Kg 45	7.5	187	0.89	6.0	418	9.2	1.8	—	112 100	—	
	10	140	0.88	5.5	552	9.2	1.4				
	15	93	0.85	4.4	803	9.2	1.1				
	20	70	0.84	4.1	860	7.5	1.1				
	25	56	0.83	3.9	778	5.5	1.2				
	30	47	0.79	3.2	883	5.5	1.1				
	40	35	0.76	2.8	829	4	1.3				
	50	28	0.74	2.6	757	3	1.3				
	65	22	0.71	2.3	678	2.2	1.2				
	80	18	0.68	2.1	649	1.8	1.2				
	100	14	0.64	1.8	655	1.5	1.1				

130	$n_1 = 900$				KC				Input - IEC B5/B14		
	i_n	n_2 [min ⁻¹]	Rd	P_{t0}	T_2 [Nm]	P_1 [kW]	FS'	132	112 100	—	
Kg 45	7.5	120	0.88	—	385	5.5	2.3	—	112 100	—	
	10	90	0.87		508	5.5	1.8				
	15	60	0.84		735	5.5	1.4				
	20	45	0.82		957	5.5	1.2				
	25	36	0.81		860	4	1.3				
	30	30	0.76		968	4	1.2				
	40	23	0.73		930	3	1.3				
	50	18	0.70		817	2.2	1.3				
	65	14	0.67		832	1.8	1.1				
	80	11	0.64		815	1.5	1.1				
	100	9	0.60		700	1.10	1.2				

130	$n_1 = 500$				KC				Input - IEC B5/B14		
	i_n	n_2 [min ⁻¹]	Rd	P_{t0}	T_2 [Nm]	P_1 [kW]	FS'	132	112 100	—	
Kg 45	7.5	67	0.86	—	228	1.85	4.9	—	112 100	—	
	10	50	0.84		297	1.85	3.7				
	15	33	0.81		429	1.85	2.9				
	20	25	0.79		558	1.85	2.5				
	25	20	0.78		689	1.85	1.8				
	30	17	0.72		763	1.85	1.7				
	40	13	0.69		975	1.85	1.5				
	50	10	0.66		1166	1.85	1.1				
	65	8	0.63		860	1.10	1.3				
	80	6	0.59		992	1.10	1.1				
	100	5	0.55		788	0.75	1.2				

* **ATTENZIONE:** la coppia massima utilizzabile $[T_{2M}]$ deve essere calcolata utilizzando il fattore di servizio: $T_{2M} = T_2 \times FS'$

* **WARNING:** Maximum allowable torque $[T_{2M}]$ must be calculated using the following service factor: $T_{2M} = T_2 \times FS'$

* **ACHTUNG:** das max. anwendbare Drehmoment $[T_{2M}]$ muss mit folgendem Betriebsfaktor berechnet werden: $T_{2M} = T_2 \times FS'$

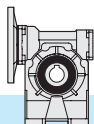

3.6 **Momenti d' inerzia** [Kg·cm²]
(riferiti all'albero veloce in entrata)

3.6 **Moments of inertia** [Kg·cm²]
(referred to input shaft)

3.6 **Trägheitsmoment** [Kg·cm²]
(bez. Antriebswelle)

	i_n	KC B5 - B14	
		IEC 56	IEC 63
		5	0.130
7.5	0.112	0.109	
10	0.103	0.100	
15	0.097	0.094	
20	0.095	0.092	
25	0.094	0.091	
30	0.093	0.090	
40	0.093	0.090	
50	0.092	0.089	
65	0.079	-	
80	0.079	-	
100	0.078	-	

	i_n	KC B5 - B14		
		IEC 56	IEC 63	IEC 71
		5	-	0.391
7.5	-	0.321	0.356	
10	-	0.272	0.347	
15	-	0.266	0.340	
20	-	0.263	0.338	
25	-	0.262	0.337	
30	-	0.262	0.337	
40	-	0.261	0.336	
50	0.182	0.261	-	
65	0.182	0.261	-	
80	0.182	0.261	-	
100	0.182	0.261	-	

	i_n	KC B5 - B14		
		IEC 63	IEC 71	IEC 80
		5	-	0.922
7.5	-	0.684	0.935	
10	-	0.602	0.853	
15	-	0.543	0.794	
20	-	0.523	0.774	
25	-	0.513	0.764	
30	-	0.508	0.759	
40	0.315	0.503	-	
50	0.313	0.501	-	
65	0.311	0.499	-	
80	0.310	0.498	-	
100	0.309	0.498	-	

	i_n	KC B5 - B14		
		IEC 71	IEC 80	IEC 63
		5	-	2.431
7.5	-	1.949	2.269	
10	-	1.744	2.063	
15	-	1.597	1.916	
20	-	1.545	1.864	
25	-	1.514	1.833	
30	-	1.508	1.828	
40	0.966	1.495	-	
50	0.959	1.488	-	
65	0.955	1.484	-	
80	0.953	1.482	-	
100	0.952	1.481	-	

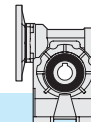



3.6 **Momenti d' inerzia** [Kg·cm²]
(riferiti all'albero veloce in entrata)

3.6 **Moments of inertia** [Kg·cm²]
(referred to input shaft)

3.6 **Trägheitsmoment** [Kg·cm²]
(bez. Antriebswelle)

	i_n	 KC		
		B5 - B14		
		IEC 80	IEC 90	IEC 100-112
K75	7.5	-	3.712	4.462
	10	-	3.234	3.984
	15	-	2.893	3.643
	20	-	2.774	3.523
	25	-	2.709	3.458
	30	-	2.689	3.438
	40	1.595	2.659	-
	50	1.578	2.642	-
	65	1.569	2.633	-
	80	1.565	2.629	-
	100	1.562	2.626	-

	i_n	 KC		
		B5 - B14		
		IEC 80	IEC 90	IEC 100-112
K90	7.5	-	6.898	7.671
	10	-	5.875	6.648
	15	-	5.144	5.917
	20	-	3.398	5.661
	25	-	3.256	5.520
	30	-	3.215	5.479
	40	-	3.151	-
	50	-	3.115	-
	65	2.024	3.096	-
	80	2.014	3.087	-
	100	2.008	3.080	-

	i_n	 KC		
		B5 - B14		
		IEC 90	IEC 100-112	IEC 132
K110	7.5	-	17.980	20.038
	10	-	15.119	17.177
	15	-	13.076	15.134
	20	-	8.367	14.418
	25	-	7.969	14.020
	30	-	11.850	13.908
	40	-	7.677	-
	50	-	7.578	-
	65	5.592	7.510	-
	80	5.570	7.489	-
	100	5.555	7.474	-

	i_n	 KC		
		B5 - B14		
		IEC 90	IEC 100-112	IEC 132
K130	7.5	-	40.70	42.78
	10	-	32.96	35.04
	15	-	27.43	29.51
	20	-	16.68	27.58
	25	-	15.52	26.42
	30	-	24.12	26.20
	40	-	14.81	25.71
	50	-	12.57	-
	65	10.46	14.35	-
	80	10.41	14.30	-
	100	10.37	14.26	-

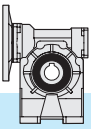

3.7 Dimensioni

3.7 Dimensions

3.7 Abmessungen

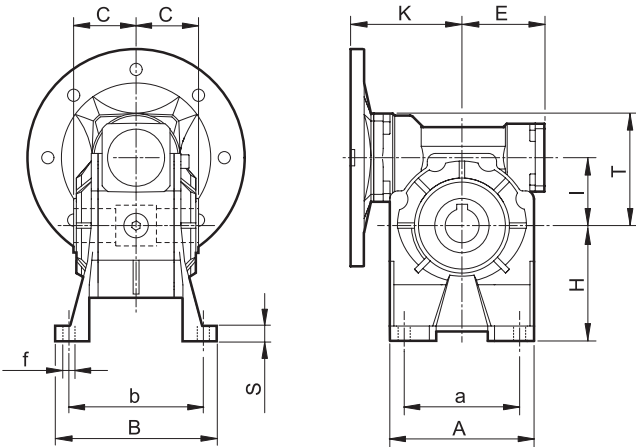

KC..A

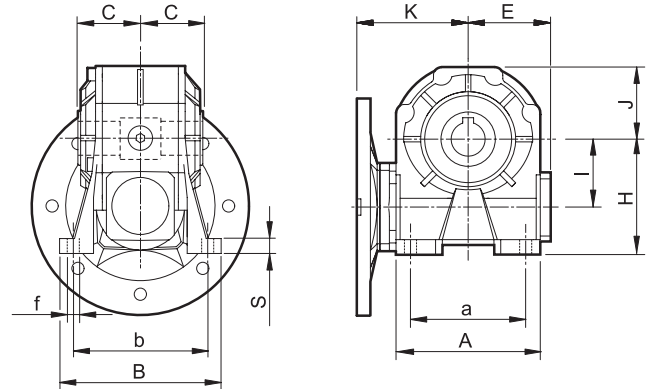

KC..B

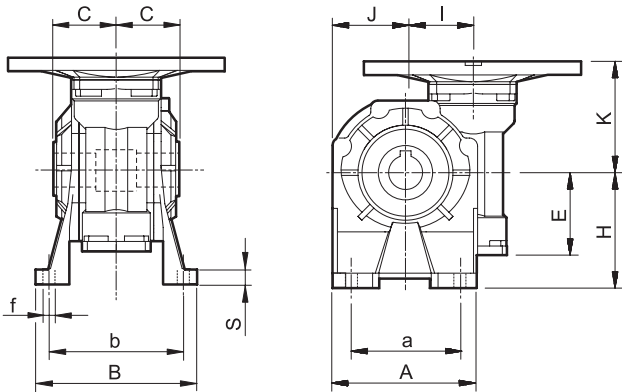

KC..V

	30	40	50	63	75	90	110	130
b2	5	6 (6)	8 (8)	8	8 (8)	10	12	14
C	31.5	39	46	56	60	70	77.5	85
D2 H8	14	18 (19)	25 (24)	25	28 (30)	35	42	45 (48)
E	41	51	60	71	85	103	127.5	147.5
G h8	55	60	70	80	95	110	130	180
I	31.5	40	50	63	75	90	110	130
J	37.5	43.5	53.5	64	78	100	122	131
K	57	75	82	97	114	122	153	173
M	M6x8	M6x10	M8x10	M8x14	M8x14	M10x18	M10x18	M12x20
Pp	29	36.5	43.5	53	57	67	74	81
R	65	75	85	95	115	130	165	215
T	52.5	68.5	82.5	100.5	116.5	131.5	161.5	181
t2	16.3	20.8 (21.8)	28.3 (27.3)	28.3	31.3 (33.3)	38.3	45.3	48.8 (51.8)
X	1.5	1.5	1.5	2	2	2	2.5	3

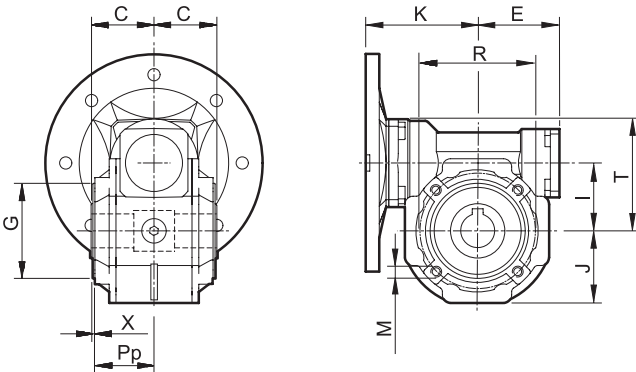

Flangia pendolare / Side cover for shaft mounting / Aufsteckflansch

	Piedi Feet Fuß	30	40	50	63	75	90	110	130
A	1	67	86.5	106	127.5	155.5	190	250	295
	2	67	86.5	106			190	250	
a	1	40-52	70	63-85	95	120	140	200	235
	2	40-52	52	63-85			140	200	220
B	1	78	98	119	136	140	168	210	229
	2	78	98	119			168	210	
b	1	66	84	99	111	115	140	162	190
	2	66	81	99			146	181	191
f	1	6.5	7	9	11	11	13	13	15
	2	6.5	8.5	9			11	13	
H	1	52	71	85	100	115	135	172	200
	2	55	72	82			142	170	195
S	1	5	9	11	12	12	14	17	20
	2	8	10	8			14	15	15

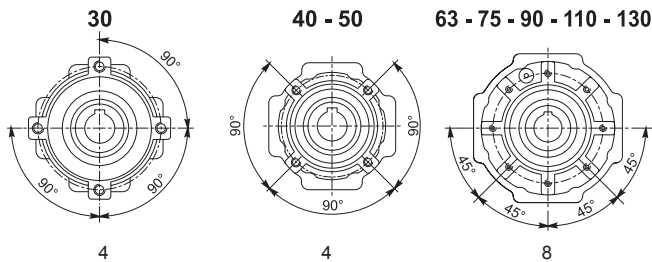

Fori / Holes / Bohrungen Fori / Holes / Bohrungen Fori / Holes / Bohrungen

KC..P

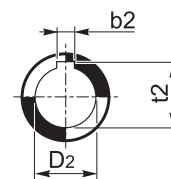

Albero uscita cavo
Hollow output shaft
Abtriebshohlwelle

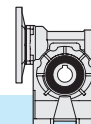

3.7 Dimensioni

3.7 Dimensions

3.7 Abmessungen

Flangia uscita / Output flange / Abtriebsflansch

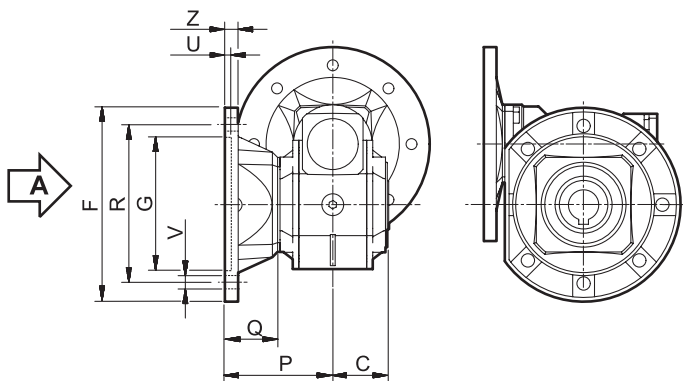

KC..F

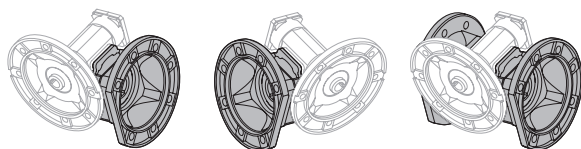

F...D
Standard

F...S

F...2

Vista da A / View from A / Ansicht von A

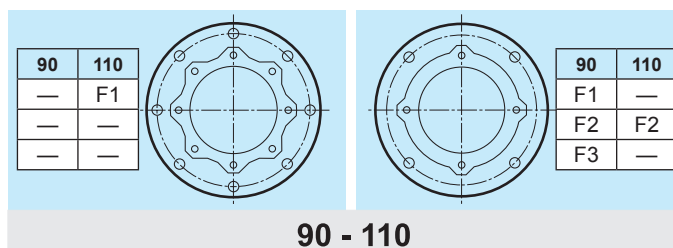
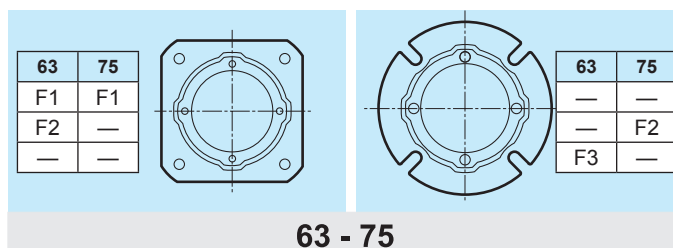
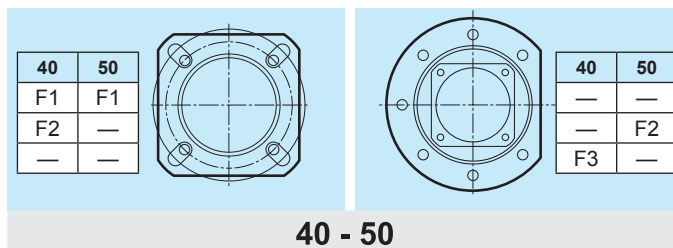
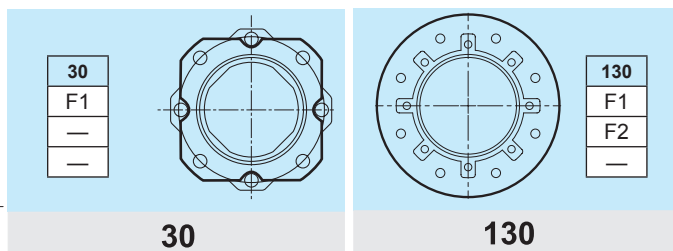

KC	C	F		G H8	P	Q	R	U	V			Z
											∅	
30	31.5		66	50	54.5	23	68	4			6.5	6
40	39		85	60	67	28	75-90	4			9	8
			85	60	97	58	75-90	4			9	8
			140	95	80	41	115	5		n° 7	9	10
50	46		94	70	90	44	85-100	5			11	10
			160	110	89	43	130	5		n° 7	11	11
63	56		142	115	82	26	150	5			11	11
			142	115	112	56	150	5			11	11
			160	110	80.5	24.5	130	5			11	12
75	60		160	130	111	51	165	5			13	12
			160	110	90	30	130	6			11	13
90	70		200	152	111	41	175	5			13	12
			200	152	151	81	175	5			13	13
			200	130	110	40	165	6			11	11
110	77.5		260	170	131	53.5	230	6		n° 8	13	15
			250	180	150	72.5	215	5			15	16
130	85		320	180	140	55	255	7		n° 8 *	16	16
			300	230			265					

* Foratura ruotata di 22.5°

* Drilling turned of 22.5°

* Durchbohrung 22.5° versetzt

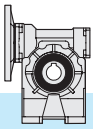

3.7 Dimensioni

3.7 Dimensions

3.7 Abmessungen

Flangia entrata / Input flange / Antriebsflansch

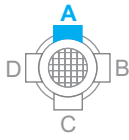

PM = 1

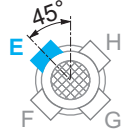

PM = 2

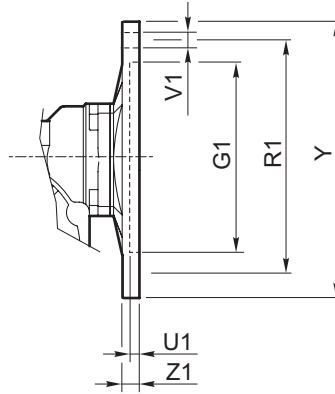

KC	IEC	G ₁	PM		R ₁	U ₁	V ₁			Y	Z ₁	Diametro fori PAM / Holes diameter IEC / IEC Durchmesser																
			1	2			Ø					5	7.5	10	15	20	25	30	40	50	65	80	100					
30	56 B5	80	•	•	100	4	7		8		120	8	9	9	9	9	9	9	9	9	9	9	9	9	9	9	9	9
	56 B14	50	•	•	65	3.5	6		8		80	8	9	9	9	9	9	9	9	9	9	9	9	9	9	9	9	9
	63 B5	95	•	•	115	4	9		8		140	8	11	11	11	11	11	11	11	11	11	11	11	11	11	/	/	/
	63 B14	60	•	•	75	4	6		8		90	8	11	11	11	11	11	11	11	11	11	11	11	11	11	/	/	/
40	56 B5	80	•	•	100	4	7		8		120	9	/	/	/	/	/	/	/	/	/	/	9	9	9	9	9	
	56 B14	50	•	•	65	3.5	6		8	4	80	8	/	/	/	/	/	/	/	/	/	/	9	9	9	9	9	
	63 B5	95	•	•	115	4	9		8		140	9	11	11	11	11	11	11	11	11	11	11	11	11	11	11	11	
	63 B14	60	•	•	75	3.5	6		8	4	90	8	11	11	11	11	11	11	11	11	11	11	11	11	11	11	11	
	71 B5	110	•	•	130	4.5	9		8		160	10	14	14	14	14	14	14	14	14	14	14	/	/	/	/	/	
	71 B14	70	•	•	85	3.5	7		8		105	8	14	14	14	14	14	14	14	14	14	14	/	/	/	/	/	
50	63 B5	95	•	•	115	4	9		8		140	9	/	/	/	/	/	/	/	/	/	11	11	11	11	11	11	
	63 B14	60	•	•	75	3.5	6		8	4	90	8	/	/	/	/	/	/	/	/	/	11	11	11	11	11	11	
	71 B5	110	•	•	130	4.5	9		8		160	10	14	14	14	14	14	14	14	14	14	14	14	14	14	14	14	
	71 B14	70	•	•	85	3.5	7		(n° 8)*	4	105	8	14	14	14	14	14	14	14	14	14	14	14	14	14	14	14	
	80 B5	130	•	•	165	4.5	11		8		200	10	19	19	19	19	19	19	19	19	19	19	/	/	/	/	/	
	80 B14	80	•	•	100	4	7		8		120	10	19	19	19	19	19	19	19	19	19	19	/	/	/	/	/	
63	71 B5	110	•	•	130	4.5	9		8		160	10	/	/	/	/	/	/	/	/	/	14	14	14	14	14	14	
	71 B14	70	•	•	85	3.5	7		8	4	105	10	/	/	/	/	/	/	/	/	/	14	14	14	14	14	14	
	80 B5	130	•	•	165	4.5	11		8		200	10	19	19	19	19	19	19	19	19	19	19	19	19	19	19	19	
	80 B14	80	•	•	100	4	7		8	4	120	10	19	19	19	19	19	19	19	19	19	19	19	19	19	19	19	
	90 B5	130	•	•	165	4.5	11		8		200	10	24	24	24	24	24	24	24	24	24	24	/	/	/	/	/	
	90 B14	95	•	•	115	4	8.5		8		140	10	24	24	24	24	24	24	24	24	24	24	/	/	/	/	/	
75	80 B5	130	•	•	165	4.5	11		8		200	10	/	/	/	/	/	/	/	/	/	19	19	19	19	19	19	
	80 B14	80	•	•	100	4	7		8	4	120	11	/	/	/	/	/	/	/	/	/	19	19	19	19	19	19	
	90 B5	130	•	•	165	4.5	11		8		200	10	/	24	24	24	24	24	24	24	24	24	24	24	24	24	24	
	90 B14	95	•	•	115	4	9		8	4	140	11	/	24	24	24	24	24	24	24	24	24	24	24	24	24	24	
	100/112 B5	180	•	•	215	5	14		8		250	13	/	28	28	28	28	28	28	28	28	28	/	/	/	/	/	
	100/112 B14	110	•	•	130	4.5	9		8		160	11	/	28	28	28	28	28	28	28	28	28	/	/	/	/	/	
90	80 B5	130	•	•	165	4.5	11		8		200	10	/	/	/	/	/	/	/	/	/	/	/	/	19	19	19	
	80 B14	80	•	•	100	4	7		8	4	120	11	/	/	/	/	/	/	/	/	/	/	/	/	19	19	19	
	90 B5	130	•	•	165	4.5	11		8		200	10	/	24	24	24	24	24	24	24	24	24	24	24	24	24	24	
	90 B14	95	•	•	115	4	9		8	4	140	11	/	24	24	24	24	24	24	24	24	24	24	24	24	24	24	
	100/112 B5	180	•	•	215	5	14		8		250	13	/	28	28	28	28	28	28	28	28	28	/	/	/	/	/	
	100/112 B14	110	•	•	130	4.5	9		8		160	11	/	28	28	28	28	28	28	28	28	28	/	/	/	/	/	
110	90 B5	130	•	•	165	5	11		4		200	12	/	/	/	/	/	/	/	/	/	24	/	24	24	24	24	
	90 B14	95	•	•	115	5	9		4	4	140	12	/	/	/	/	/	/	/	/	/	24	/	24	24	24	24	
	100/112 B5	180	•	•	215	5	14		4		250	14	/	28	28	28	28	28	28	28	28	28	28	28	28	28	28	
	100/112 B14	110	•	•	130	5	9		4	4	160	12	/	28	28	28	28	28	28	28	28	28	28	28	28	28	28	
	132 B5	230	•	•	265	5	14		4		300	14	/	38	38	38	38	38	38	38	38	38	/	/	/	/	/	
	132 B14	130	•	•	165	5	11		4		200	12	/	38	38	38	38	38	38	38	38	38	/	/	/	/	/	
130	90 B5	130	•	•	165	5	11		4		200	12	/	/	/	/	/	/	/	/	/	/	/	/	24	24	24	
	90 B14	95	•	•	115	5	9		4	4	140	12	/	/	/	/	/	/	/	/	/	/	/	/	24	24	24	
	100/112 B5	180	•	•	215	5	14		4		250	14	/	28	28	28	28	28	28	28	28	28	28	28	28	28	28	
	100/112 B14	110	•	•	130	5	9		4	4	160	12	/	28	28	28	28	28	28	28	28	28	28	28	28	28	28	
	132 B5	230	•	•	265	5	14		4		300	14	/	38	38	38	38	38	38	38	38	38	/	/	/	/	/	
	132 B14	130	•	•	165	5	11		4		200	12	/	38	38	38	38	38	38	38	38	38	/	/	/	/	/	

* A richiesta, solo con corpo speciale / Upon request, only with special body / Auf Wunsch nur mit speziellen Körper

N.B.: Il montaggio STD di $P_M=2$ solo quando non è possibile il montaggio STD di $P_M=1$.

N.B.: E' possibile realizzare anche tutte le composizioni ibride ottenibili dalle flange esistenti.

N.B.: STD mounting of $P_M=2$ only if STD mounting of $P_M=1$ is not possible.

N.B.: it is possible to create hybrid combinations with the existing flanges.

ANMERKUNG: STD Montage von $P_M=2$ nur wenn STD Montage von $P_M=1$ unmöglich ist.

ANMERKUNG: Mischkombinationen mit der verfügbaren Flanschen sind möglich.

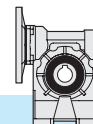

3.8 Entrata supplementare (vite bisporgente)

3.8 Additional input (double extended shaft)

3.8 Zusatzantrieb (beidseitige Welle)

S.e.A.

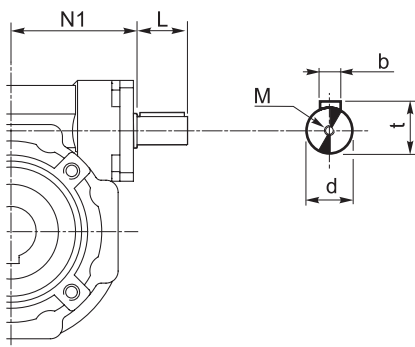

KC	d j6	L	M	N1	b	t
30	9	15	M4x10	42.5	3	10.2
40	11	20	M4x12	52.5	4	12.5
50	14	25	M5x13	62.5	5	16
63	19	30	M8x20	72.5	6	21.5
75	24	40	M8x20	89	8	27
90	24	40	M8x20	108	8	27
110	28	50	M8x20	132.5	8	31
130	38	70	M10x25	152	10	41

3.9 Limitatore di coppia cavo passante

3.9 Torque limiter with through hollow shaft

3.9 Drehmomentbegrenzer mit durchgehender Hohlwelle

Il limitatore di coppia viene consigliato in tutte quelle applicazioni che richiedono una limitazione sulla coppia trasmissibile per proteggere l'impianto e/o preservare il riduttore evitando sovraccarichi o urti indesiderati quanto inaspettati.

È un dispositivo con albero dotato di cavo passante, con funzionamento a frizione, ed è integrato al riduttore, presentando un ingombro limitato.

Concepito per lavorare a bagno d'olio, il dispositivo risulta affidabile nel tempo ed è esente da usura se non viene mantenuto in condizioni prolungate di slittamento (condizione che si verifica quando la coppia presenta valori superiori a quelli di taratura).

La taratura è facilmente regolabile dall'esterno attraverso il serraggio di una ghiera autobloccante che porta a compressione le 4 molle a tazza disposte tra loro in serie.

Il dispositivo non consente:

- l'impiego di cuscinetti a rulli conici in uscita
- funzionamento prolungato in condizioni di slittamento.

Nella tabella seguente vengono riportati i valori delle coppie di slittamento M_{2S} in funzione del n° di giri della ghiera.

I valori di taratura presentano una tolleranza del $\pm 10\%$ e si riferiscono ad una condizione statica.

In condizioni dinamiche è da notare che la coppia di slittamento assume valori diversi a seconda del tipo e/o modalità in cui si verifica il sovraccarico: con valori maggiori in caso di carico uniformemente crescente rispetto a valori più contenuti in seguito al verificarsi di picchi improvvisi di carico.

NOTA: quando si supera il valore di taratura si ha slittamento. Il coefficiente di attrito tra le superfici di contatto da statico diventa dinamico e la coppia trasmessa cala del 30% circa.

E' quindi opportuno prevedere uno stop per poter ripartire al valore di taratura iniziale.

The use of a torque limiter is advisable when the application requires the limitation of the transmissible torque to safeguard the plant and/or the gearbox from unexpected or undesired overloads.

The torque limiter is equipped with a through hollow shaft and a friction clutch. It is integrated in the gearbox, therefore space requirement is limited.

Designed to be working in oil bath, the device is reliable over time and is not subject to wear unless in case of operation with prolonged slipping (it occurs when the torque values are higher than the calibration values).

Calibration can be easily adjusted from outside by tightening the self-locking ring nut, which causes the compression of the 4 Belleville washers arranged in series.

The device does not go together with:

- the use of tapered roller bearings at output
- prolonged operation under slipping conditions

The following table shows the values of M_{2S} slipping torques depending on the number of revolutions of the ring nut.

Calibration values feature a $\pm 10\%$ tolerance and refer to static conditions.

Under dynamic conditions the values of the slipping torque will change according to the type of overload: the values are higher if the load increase is uniform; the values are lower if sudden load peaks occur.

NOTE: *Slipping occurs when the setting values are exceeded.*

The friction coefficient between the contact surfaces from static becomes dynamic and the transmitted torque is approx. 30% lower.

It is advisable to have a stop first in order to have a restart based on the initial setting value.

Die Anwendung eines Drehmomentbegrenzers wird empfohlen, um die Anlage und/oder das Getriebe gegen ungewünschte und unerwartete Überbelastungen zu schützen.

Es handelt sich um eine Vorrichtung mit einer durchgehender Hohlwelle.

Er ist in dem Getriebe integriert, d.h. der Raumbedarf ist klein. Der Begrenzer wurde für Betrieb in einem Ölbad entworfen.

Er ist zuverlässig über Zeit und verschleißfest (ausser wenn Rutschen für lange Zeit besteht: das passiert, wenn das Drehmoment höher als der Eichwert ist).

Die Einstellung darf mühelos von aussen durch das Anziehen einer selbstsperrenden Mutter ausgeführt werden. Das Anziehen verursacht die Zusammendrückung der 4 wechelsinnigeschichteten Tellerfeder.

Die Vorrichtung sieht das folgende nicht vor:

- die Verwendung von Kegelrollenlager am Abtrieb
- Längerer Rutschbetrieb

Die nachstehende Tabelle zeigt die Werte der Rutschmomente M_{2S} abhängig von der Zahl der Umdrehungen der Mutter.

Die Eichwerte weisen $\pm 10\%$ Toleranz auf und beziehen sich auf statische Bedingungen.

Unter dynamischen Bedingungen hat das Rutschmoment verschiedene Werte je nach Art der Überbelastung. Die Werte sind höher, wenn die Belastung gleichmäßig zunimmt; sie sind niedriger im Falle von plötzlichen Belastungsspitzen.

BEMERKUNG: Rutschen tritt auf, wenn die eingestellten Werte überschritten werden. Der Reibungskoeffizient zwischen den Berührungsflächen wird dynamisch anstatt statisch und das übertragene Drehmoment sinkt um ca. 30%.

Es ist daher ratsam, vor dem erneuten Anfahren anzuhalten, um die ursprünglichen Drehmomentwerte zu erreichen.

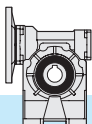

E' importante notare che la coppia di slittamento non resta sempre la medesima durante tutta la vita del limitatore.

Tende infatti a diminuire in rapporto al numero e alla durata degli slittamenti che, rodando le superfici di contatto, ne aumentano il rendimento.

È quindi opportuno verificare periodicamente, soprattutto durante la fase di rodaggio, la taratura del dispositivo.

Là dove sia richiesto un errore più contenuto nella taratura, è necessario testare la coppia trasmissibile sull'impianto.

Il dispositivo viene consegnato tarato alla coppia riportata a catalogo T_{2M} salvo diversa indicazione espressa in fase di ordinazione.

It is important to note that the slipping torque is not the same for the entire life of the torque limiter.

It usually decreases in connection with the number and the duration of slippings, this is due to the surfaces of the torque limiter becoming more engaged, therefore increasing the efficiency.

For this reason it is advisable to check the calibration of the device at regular intervals, specially during the running-in period.

Should a smaller calibration error be required, it is necessary to test the transmissible torque on the plant.

The torque limiter is supplied already calibrated at the torque value reported in the catalogue T_{2M} , unless otherwise specified in the order.

Es ist wichtig zu beachten, dass das Rutschmoment der Rutschkupplung über die gesamte Lebensdauer nicht konstant bleibt, sondern üblicherweise in Verbindung mit längeren Rutschzyklen aufgrund der eingelaufenen Berührungsflächen abnimmt.

Deswegen ist es ratsam, die Einstellung der Vorrichtung besonders während der Einlaufzeit in regelmäßigen Zeitabständen zu prüfen.

Falls ein niedriger Eichfehler verlangt wird, ist das übersetzbare Drehmoment auf der Anlage zu testen.

Wenn die Vorrichtung geliefert wird, ist sie schon auf dem im Katalog T_{2M} angegebenen Drehmoment geeicht, ausser wenn es in der Bestellung anders angegeben wird.

K	N°. giri della ghiera di regolazione / N°. revolutions of ring nut / Nr. Umdrehungen der Mutter																
	3/4	1	1 1/4	1 1/2	1 3/4	2	2 1/4	2 1/2	2 3/4	3	3 1/4	3 1/2	3 3/4	4	4 1/4	4 1/2	
	M_{2S} [Nm]																
30		15	18	22	27	32											
40	23	30	35	40	45	50	60										
50		45	60	70	80	90	100	110									
63			80	90	100	110	120	130	140	150	160	170	180	190	200		
75		140	160	180	200	220	240	260	280	300							
90						230	280	310	330	350	380	410	435	460	490	510	
110		420	500	560	670	730	810	910									
130																	

Disposizione delle molle
Washers' arrangement
Lage der Feder

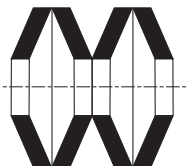

IN SERIE (min. coppia, max. sensibilità)
SERIES (min. torque, max sensitivity)
SERIE (min. Moment, max. Empfindlichkeit)

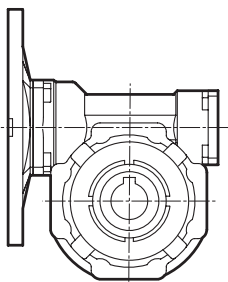
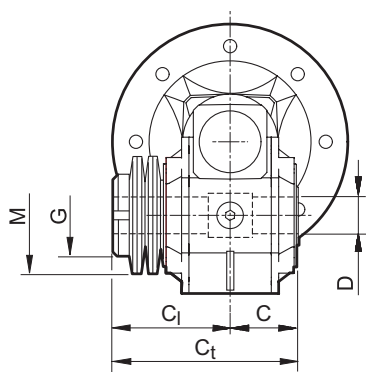

KC	C	C ₁	C _t	D _{H8}	M	G
30	31.5	55.5	87	14	50x25.4x1.25	M25x1.5
40	39	65	104	18 (19)	56x30.5x1.5	M30x1.5
50	46	76	122	25 (24)	63x40.5x1.8	M40x1.5
63	56	91	147	25	71x40.5x2	M40x1.5
75	60	100	160	28 (30)	90x50.5x2.5	M50x1.5
90	70	109	179	35 (32)	100x51x2.7	M50x1.5
110	77.5	127.5	205	42	125x61x4	M60x2.0
130						

() A richiesta / On request / Auf Anfrage

Nella versione con limitatore non è prevista la fornitura degli alberi lenti.

The version with torque limiter is supplied without output shafts.

Die Version mit Drehmomentbegrenzer wird ohne Abtriebswellen geliefert.

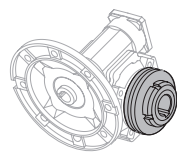

LD

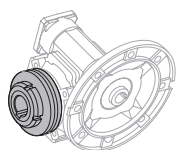

LS



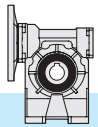

3.10 Accessori

3.10 Accessories

3.10 Accessories

Albero lento

Output shaft

Abtriebswelle

Albero lento semplice
Single output shaft
Standard Abtriebswelle

Albero lento doppio
Double output shaft
Doppelte Abtriebswelle

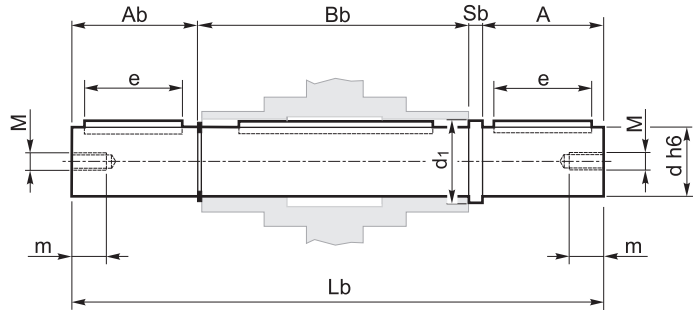
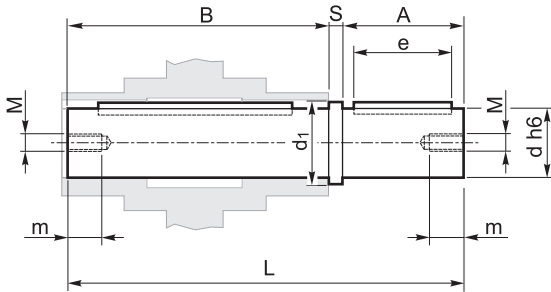

KC	A	B	d _{h6}		d ₁	e	L	M	m	S
30	30	62	14		18.5	20	94.5	M6	16	2.5
40	40	77	18	19	23.5	30	120	M6	16	3
50	50	90	25	24	31.5	40	143.5	M8	22	3.5
63	50	111	25		31.5	40	165	M8	22	4
75	60	119	28	30	34.5	50	183	M8	22	4
90	80	139	35		41.5	60	224	M10	28	5
110	80	154.5	42		49.5	60	242.5	M10	28	8
130	80	168	45		54.5	70	253	M16	36	5

A	A _b	B _b	d _{h6}	d ₁	e	L _b	S _b
30	29	64	14	18.5	20	126	2.5
40	39	79	18	23.5	30	161	3
50	49	93	25	31.5	40	195.5	3.5
50	49	113	25	31.5	40	216	4
60	59	121	28	34.5	50	244	4
80	78.5	141.5	35	41.5	60	305	5
80	77.5	157	42	49.5	60	322.5	8
80	78	172	45	54.5	70	335	5

Braccio di reazione

Torque arm

Drehmomentstütze

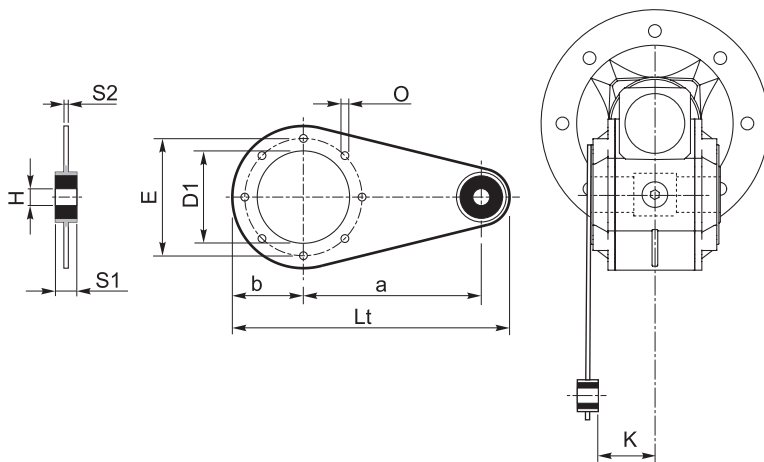

KC	a	b	D ₁	E	H	K	L _t	O	S1	S2
30	85	37.5	55	65	8	24	141.5	7	14	4
40	100	45	60	75	10	31.5	167	7	14	4
50	100	50	70	85	10	39	172	9	14	5
63	150	55	80	95	10	49	227	9	14	6
75	200	70	95	115	20	47.5	302	9	25	6
90	200	80	110	130	20	57.5	312	11	25	6
110	250	100	130	165	25	62	390	11	30	6
130	250	125	180	215	25	69	415	13	30	6

Kit di protezione: solo su versione P

Protection Kit: only for P Version

Schutzvorrichtung: nur für Version P

Albero cavo / Hollow shaft / Hohlwelle

Limitatore di coppia / Torque limiter / Drehmomentbegrenzer

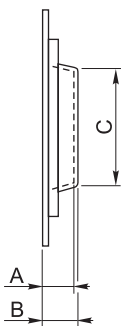

KC	A	B	C
30	12	13	39
40	14	15.5	44
50	15	16.5	54
63	17	19	60
75	18	20	70
90	21.5	24	80
110	22	25	96
130	22	25	130

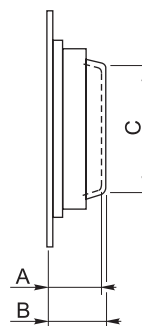

KC	A	B	C
30	36	37	36
40	40	41.5	44
50	47	48.5	53
63	52	54	55
75	58	60	68
90	60.5	63	70
110	72	75	85
130			

Opzioni disponibili:

Available options:

Auf Anfrage ist folgendes Zubehör erhältlich:

Cuscinetti a rulli conici corona

Tapered roller bearing for worm wheel

Kegelrollenlager für Schneckenrad

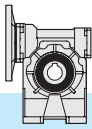

KC

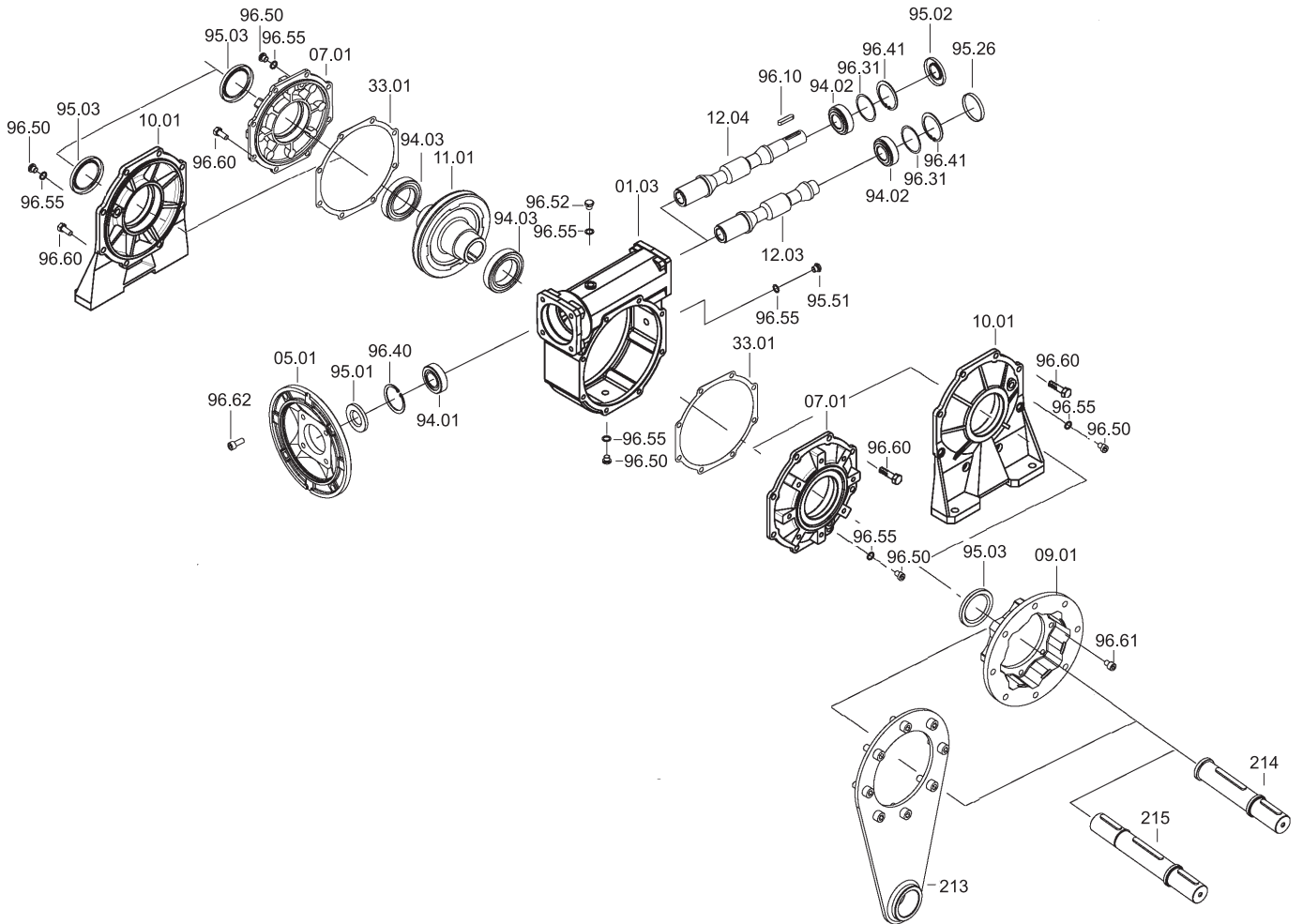

KC	IEC	Cuscinetti / Bearings / Lager				Anelli di tenuta / Oilseals Öldichtungen			Cappellotto / Closed oil seal Geschlossene Öldichtung
		94.01	94.02	94.03		95.01	95.02	95.03	95.26
30	56	61804 (20x32x7)	6000	6005	*32005	20/32/7	10/26/7	25/40/7	ø 26x7
	63	61804 (20x32x7)	10x26x8	25x47x12	25x47x15	20/32/7			
40	56	6303 (17x47x14)	6201	6006	*32006	17/47/7	12/32/7	30/47/7	ø 32x7
	63	6204 (20x47x14)		30x55x13	30x55x17	30x55x17			
	71	6005 (25x47x12)		25/47/7					
50	63	6204 (20x47x14)	6203	6008	*32008	20/47/7	17/40/7	40/62/8	ø 40x7
	71	6005 (25x47x12)		40x68x15	40x68x19	25/47/7			
	80	6006 (30x55x13)		17x40x12	30/55/7				
63	71	30305 (25x62x18.25)	30204	6008	*32008	25/62/7	20/47/7	40/62/8	ø 47x7
	80	30206 (30x62x17.25)		40x68x15	40x68x19	30/62/7			
	90	32007 (35x62x18)		20x47x15.25	35/62/7				
75	80	30206 (30x62x17.25)	30205	6010	*32010	30/62/7	25/52/7	50/72/8	ø 52x7
	90	32007 (35x62x18)		50x80x16	50x80x20	35/62/7			
	100/112	32008 (40x68x19)		25x52x16.25	40/68/10				
90	80	30206 (30x62x17.25)	32205B	6010	*32010	30/62/7	25/52/7	50/72/8	ø 52x7
	90	32007 (35x62x18)		50x80x16	50x80x20	35/62/7			
	100/112	32008 (40x68x19)		25x52x19.25	40/68/10				
110	90	30208 (40x80x19.75)	32206B	6012	*32012	40/80/10	30/62/7	60/85/8	ø 62x7
	100/112	30208 (40x80x19.75)		60x95x18	60x95x23	40/80/10			
	132	32010 (50x80x20)		30x62x21.25	50/80/10				
130	90	30208 (40x80x19.75)	33208	6015	*32015	40/80/10	40/80/10	75/100/10	ø 80x10
	100/112	30208 (40x80x19.75)		75x115x20	75x115x25	40/80/10			
	132	32010 (50x80x20)		40x80x32	50/80/10				

* Cuscinetti a rulli conici a richiesta - Tapered roller bearings on request - Auf Wunsch Kegelrollenlager